



**MOPEDIA®**

MA RP729x-RP73x-RP74x 07 A\_ITA\_08 2020

**DEAMBULATORI BASSI**

**MANUALE DI ISTRUZIONI**

ITALIANO

## INDICE

1. CODICI.....	PAG.3
2. INTRODUZIONE.....	PAG.3
3. DESTINAZIONE D'USO.....	PAG.3
4. DICHIARAZIONE DI CONFORMITÀ UE .....	PAG.4
5. AVVERTENZE GENERALI .....	PAG.4
6. SIMBOLOGIA UTILIZZATA.....	PAG.4
7. DESCRIZIONE GENERALE .....	PAG.5
7.1 Regolazione altezza.....	pag. 5
8. PRIMA DI OGNI USO.....	PAG.5
9. AVVERTENZE PER L'UTILIZZO .....	PAG.5
10. ISTRUZIONI DI MONTAGGIO RP729X .....	PAG.6
11. MODALITÀ D'USO.....	PAG.6
12. MANUTENZIONE .....	PAG.7
13. PULIZIA E DISINFEZIONE .....	PAG.8
13.1 Pulizia.....	pag. 8
13.2 Disinfezione .....	pag. 8
14. CONDIZIONI DI SMALTIMENTO .....	PAG.8
15. CARATTERISTICHE TECNICHE .....	PAG.8
15.1 Parti di ricambio ed accessori .....	pag. 10
16. GARANZIA.....	PAG.11
17. RIPARAZIONI.....	PAG.11
17.1 Riparazione in garanzia .....	pag. 11
17.2 Riparazione di un prodotto non coperto dalla garanzia.....	pag. 11
17.3 Prodotti non difettosi.....	pag. 11
18. RICAMBI.....	PAG.11
19. CLAUSOLE ESONERATIVE.....	PAG.11

 Dispositivo medico di classe I

REGOLAMENTO (UE) 2017/745 DEL PARLAMENTO EUROPEO E DEL CONSIGLIO  
del 5 aprile 2017 relativo ai dispositivi medici

## 1. CODICI

### Deambulatori con quattro puntali

RP729M-L	Deambulatore fisso altezza regolabile
RP730M-L	Deambulatore pieghevole con 1 pulsante - regolabile in altezza
RP747	Deambulatore pieghevole doppio appoggio regolabile in altezza
RP749M-L	Deambulatore pieghevole doppia funzione fisso/oscillante - regolabile in altezza

### Deambulatori con due ruote e due puntali

RP734	Deambulatore pieghevole regolabile in altezza 2 ruote piroettanti
RP735S-M-L	Deambulatore pieghevole regolabile in altezza 2 ruote fisse
RP737	Deambulatore pieghevole regolabile in altezza 2 puntali con sistema autobloccante

### Deambulatori con quattro ruote

RP733S-M-L	Deambulatore pieghevole regolabile in altezza ruote piroettanti
RP738	Deambulatore pieghevole regolabile in altezza 2 ruote con sistema autobloccante
RP741	Deambulatore pieghevole regolabile in altezza, 4 ruote piroettanti di cui 2 con freno
RP748	Deambulatore smontabile regolabile in altezza, 2 ruote piroettanti con freno e 2 ruote piroettanti
RP742	Deambulatore pieghevole regolabile in altezza con freno azionabile a mano
RP743	Deambulatore pieghevole regolabile in altezza con 2 ruote gemellate con rotazione frizionata

## 2. INTRODUZIONE

Grazie per aver scelto un ausilio della linea MOPEDIA by Moretti. I deambulatori Moretti sono stati progettati e realizzati per soddisfare tutte le vostre esigenze per un utilizzo pratico, corretto e sicuro. Questo manuale contiene dei piccoli suggerimenti per un corretto uso del dispositivo da voi scelto e dei preziosi consigli per la vostra sicurezza. Si consiglia di leggere attentamente la totalità del presente manuale prima di usare il dispositivo. In caso di dubbi vi preghiamo di contattare il rivenditore, il quale saprà aiutarvi e consigliarvi correttamente.

## 3. DESTINAZIONE D'USO

I deambulatori MOPEDIA by Moretti sono ausili maneggiati da due braccia adatti a sostenere e/o aiutare la mobilità di persone con difficoltà di deambulazione.

### ATTENZIONE!



- È vietato l'utilizzo del seguente dispositivo per fini diversi da quanto definito nel presente manuale.
- Moretti S.p.A. declina qualsiasi responsabilità su danni derivanti da un uso improprio del dispositivo o da un uso diverso da quanto indicato nel presente manuale.
- Il produttore si riserva il diritto di apportare modifiche al dispositivo e al seguente manuale senza preavviso allo scopo di migliorarne le caratteristiche.

#### 4. DICHIARAZIONE DI CONFORMITÀ UE

La MORETTI SpA dichiara sotto la sua esclusiva responsabilità che i prodotti fabbricati ed immessi in commercio dalla stessa MORETTI SpA, e facenti parte della famiglia DEAMBULATORI BASSI MOPEDIA sono conformi alle disposizioni applicabili del regolamento 2017/745 sui DISPOSITIVI MEDICI del 5 aprile 2017.

A tal scopo la MORETTI SpA garantisce e dichiara sotto la propria esclusiva responsabilità quanto segue:









1. I dispositivi in oggetto soddisfano i requisiti generali di sicurezza e prestazione così come richiesti dall'allegato I del regolamento 2017/745 come prescritto dall'allegato IV del suddetto regolamento.
2. I dispositivi in oggetto NON SONO STRUMENTI DI MISURA.
3. I dispositivi in oggetto NON SONO DESTINATI AD INDAGINI CLINICHE.
4. I dispositivi in oggetto vengono commercializzati in confezione NON STERILE.
5. I dispositivi in oggetto sono da considerarsi come appartenenti alla classe I in conformità a quanto stabilito dall'allegato VIII del suddetto regolamento.
6. La MORETTI SpA mantiene e mette a disposizione delle Autorità Competenti, per almeno 10 anni dalla data di fabbricazione dell'ultimo lotto, la documentazione tecnica comprovante la conformità al regolamento 2017/745.

**Nota:** I codici completi di prodotto, il codice di registrazione del Fabbricante (SRN), il codice UDI-DI di base ed eventuali riferimenti a norme utilizzate sono riportati nella Dichiarazione di Conformità UE che MORETTI SPA emette e rende disponibile attraverso i propri canali.

#### 5. AVVERTENZE GENERALI

- Per un utilizzo corretto del dispositivo fare riferimento al presente manuale.
- Per un utilizzo corretto del dispositivo consultare sempre il vostro medico o terapeuta.
- Verificare che il prodotto vi sia consegnato integro e mantenerlo imballato lontano da fonti di calore.
- La vita utile del dispositivo è determinata dall'usura di parti non riparabili e/o sostituibili.
- Prestare sempre attenzione alla presenza di bambini.
- L'utilizzatore e/o il paziente dovrà segnalare qualsiasi incidente grave verificatosi in relazione al dispositivo al fabbricante e all'autorità competente dello Stato membro in cui l'utilizzatore e/o il paziente è stabilito.

#### 6. SIMBOLOGIA UTILIZZATA

	Codice prodotto
	Identificativo univoco del dispositivo
	Marchio CE
	Fabbricante
	Lotto di produzione
	Leggere il manuale per le istruzioni
	Dispositivo Medico
	Condizioni di smaltimento

## 7. DESCRIZIONE GENERALE

I Deambulatori MOPEDIA sono realizzati in alluminio anodizzato leggero, sono pieghevoli o smontabili (tranne RP729) hanno manopole imbottite e/o puntali antiscivolo e ruote fisse o piroettanti. Regolabili in altezza ogni 2.5 cm. I suddetti dispositivi facilitano lo spostamento a persone con limitato equilibrio statico e/o dinamico, aumentando l'ampiezza alla base d'appoggio. Forniscono sostegno nelle situazioni di ipostenia e/o paresi degli arti inferiori. Aiutano a scaricare sulle braccia parte del peso della persona, quando sia richiesta una limitazione del carico su uno o entrambi gli arti inferiori.

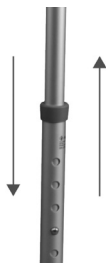

### 7.1 Regolazione altezza

Premere il pulsante a molla e sfilare la canna portandola in corrispondenza dei fori in base all'altezza desiderata e alla manovrabilità soggettiva del paziente stesso. Riposizionare il fermo sul foro per bloccare la canna e assicurarsi che il fermo sia ben inserito prima dell'utilizzo del dispositivo stesso. Controllare che tutte e quattro le gambe siano alla stessa altezza.

## 8. PRIMA DI OGNI USO

- Verificare sempre che i freni funzionino prima di usare il deambolatore, dove presenti;
- Non usare il deambolatore se è danneggiato o presenta malfunzionamenti;
- Contattare il rivenditore per eventuali riparazioni;
- Gli utenti devono muoversi su percorsi pedonali e non su strade trafficate;
- Tenere conto della possibilità di lesioni da intrappolamento; evitare di collocare le dita tra le parti mobili del deambolatore. Prestare particolare attenzione chiudendo e aprendo il deambolatore.

## 9. AVVERTENZE PER L'UTILIZZO

Questo dispositivo fornisce una maggiore stabilità, sostegno e sicurezza durante la marcia. In ogni caso, non può essere usato da persone con una funzionalità della mano e/o del braccio visibilmente debole e anche da persone con problemi di equilibrio. Il deambolatore può essere usato sia all'esterno che all'interno. Si consiglia l'uso solamente su superfici sulle quali tutte e quattro le gambe toccano per terra. Non deve essere usato su terreno roccioso o su piani inclinati perché il deambolatore può risultare instabile. Il dispositivo non è concepito per il trasporto di persone o altro materiale.

- Usare con prudenza su superfici bagnate e scivolose;
- Non superare il peso massimo paziente riportato sull'etichetta prodotto e nel capitolo caratteristiche tecniche del presente manuale;
- Evitare l'impiego su pendii superiori ai 10 (gradi) e per girarsi su un piano inclinato il disabile deve essere assistito da un operatore;
- Verificare periodicamente la stabilità e robustezza del prodotto nonché lo stato dei puntali di appoggio e delle ruote. Sostituirli una volta usurati;
- In caso di dubbi sull'utilizzo, sulla regolazione o sulla manutenzione del prodotto, contattare il rivenditore;
- Per evitare eventuali rischi tenere il dispositivo lontano dalla portata dei bambini.

## 10. ISTRUZIONI DI MONTAGGIO RP729X

Lista parti

1. Telaio portante (1 Pz)
2. Gambe (2 Pz)
3. Tubo piegato (1 Pz)
4. Kit di assemblaggio (1 Pz)

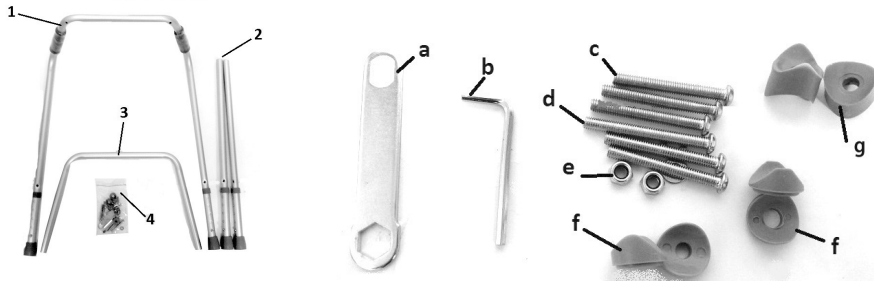

- a. Aprire il Kit di assemblaggio e iniziare l'assemblaggio prendendo il telaio portante (1).
- b. Assemblare sul telaio portante (1) le gambe (2) con le rondelle a sella (f) e le viti corte (c).  
Non serrare completamente le viti.
- c. Assemblare sul lato anteriore del telaio portante (1) il tubo piegato (3) con le rondelle a sella (g), le viti lunghe (d) e dado con rondella (e). Non serrare completamente le viti.
- d. Assemblare sulle gambe (2) il tubo piegato (3) con le rondelle a sella (f) e le viti corte (c).  
Non serrare completamente le viti.
- e. Stringere bene tutte le viti, il deambulatore è così pronto all'uso. (Vedi foto sotto)

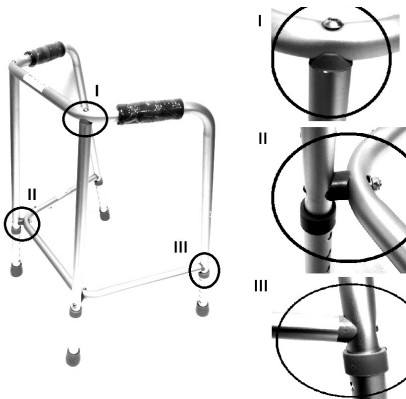

## 11. MODALITÀ D'USO

**Nota:** Fare riferimento alle avvertenze di sicurezza di questo manuale di istruzioni. Utilizzare il deambulatore come dispositivo di aiuto per la deambulazione. Per fare questo utilizzare le due impugnature e spingere in avanti l'ausilio ottenendo così un supporto pratico e affidabile per camminare.

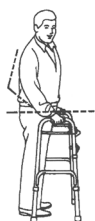

Con il braccio steso, l'impugnatura del deambulatore deve essere all'altezza del polso. Con la mano appoggiata sull'impugnatura, il gomito deve essere piegato di 20°-30°.



**ATTENZIONE!**

Alla presenza di fili elettrici a terra, pavimento bagnato, tappeti, giocattoli o altri ostacoli, mobili, scalini e pavimenti sconnessi. Non usare deambulatore per salire o scendere le scale o sulle scale mobili.



1. Per trasferire il paziente dalla carrozzina al deambulatore assicurarsi che le ruote della carrozzina e del deambulatore (se provvisto) siano bloccate.



**ATTENZIONE!**

Per il trasferimento e i primi passi farsi aiutare da un operatore.



2. a) Deambulatori con puntali: per camminare con il deambulatore, alzarlo e posarlo comodamente davanti a se stessi assicurandosi che tutte e quattro le gambe siano appoggiate a terra. Camminare con prudenza facendo un passo alla volta.

b) Deambulatori con ruote: Per camminare con il deambulatore, spingerlo comodamente davanti a se stessi assicurandosi che tutte e quattro le gambe, anche quelle dotate di ruote siano appoggiate a terra. Camminare con prudenza facendo un passo alla volta.

**Nota:** Il deambulatore deve essere sempre impugnato per le manopole.



**ATTENZIONE!**

Non spingere il deambulatore troppo lontano dal corpo. Questo potrebbe causare cadute e carichi inadeguati.

**12. MANUTENZIONE**

I dispositivi della linea MOPEDIA by Moretti al momento dell'immissione in commercio sono controllati accuratamente e provvisti di marchio CE. Per la sicurezza del paziente e del medico si raccomanda di far controllare dal produttore o da un laboratorio autorizzato, almeno ogni 2 anni, l'idoneità all'uso del vostro prodotto. Per ispezione periodica si intende un esame delle seguenti parti:

- La struttura portante del deambulatore e parti di collegamento;
- Controllare montaggio e funzionamento delle ruote con relativo freno, dove presenti;
- Verificare tutti i punti di saldatura;
- Verificare l'usura dei puntali ove presenti.

In caso di riparazione devono essere utilizzati soltanto ricambi ed accessori originali.

## 13. PULIZIA E DISINFEZIONE

### 13.1 Pulizia

Utilizzare esclusivamente un panno umido per rimuovere la polvere, usare un panno umido con del sapone neutro per rimuovere lo sporco più difficile. Asciugare bene prima dell'utilizzo. Utilizzare acqua ad una temperatura non superiore ai 30 °C. Non utilizzare macchine di lavaggio a getto di acqua e/o vapore.

### 13.2 Disinfezione







Se è necessario effettuare una disinfezione del prodotto utilizzare un comune detergente disinfettante.

**Nota:** Evitare assolutamente l' utilizzo di prodotti acidi, alcalini o solventi come ad esempio l'acetone o il diluente.

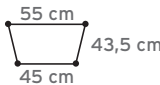
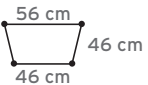
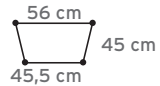
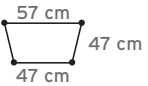
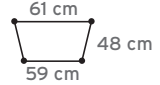
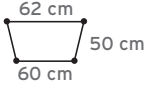
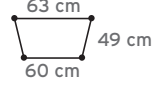
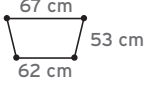

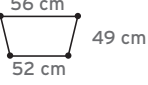

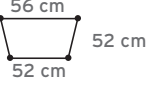

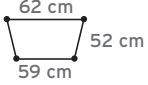











## 14. CONDIZIONI DI SMALTIMENTO









In caso di smaltimento del dispositivo non usare mai i normali sistemi di conferimento dei rifiuti solidi urbani. Si raccomanda invece di smaltire il dispositivo attraverso le comuni isole ecologiche comunali per le previste operazioni di riciclo dei materiali utilizzati.

## 15. CARATTERISTICHE TECNICHE

Codici	Portata max	H regolabile ogni 2,5 cm	Puntali/ruote	Base*	Base**
RP729M	110 Kg	Da 76 a 86 cm	4 puntali		
RP729L		Da 86 a 96 cm			
RP730M	110 Kg	Da 77 a 87 cm	4 puntali		
RP730L		Da 83 a 101 cm			
RP749M	130 kg	Da 77,5 a 87,5 cm	4 puntali		
RP749L		Da 83,5 a 101,5 cm			
RP747	130 kg	Da 71 a 89 cm	4 puntali		



Codici	Portata max	H regolabile ogni 2,5 cm	Puntali/ruote	Base*	Base**
RP735S	130 kg	Da 68,5 a 78,5 cm	2 ruote e 2 puntali	 62 cm 46 cm 59 cm	 63 cm 48 cm 60 cm
RP735M	130 kg	Da 76 a 86 cm	2 ruote e 2 puntali	 63 cm 48 cm 60 cm	 65 cm 50 cm 62 cm
RP735L	130 kg	Da 83 a 101 cm	2 ruote e 2 puntali	 63 cm 49,5 cm 60 cm	 65 cm 53,5 cm 62 cm
RP737	130 kg	Da 84 a 102 cm	2 ruote e 2 puntali	 61 cm 53 cm 62 cm	 64 cm 57 cm 65 cm
RP734	130 kg	Da 84 a 102 cm	2 ruote e 2 puntali	 61 cm 50 cm 60 cm	 63 cm 54 cm 61,5 cm
RP738	130 kg	Da 84 a 102 cm	4 ruote	 66 cm 55 cm 62 cm	 69 cm 59 cm 64 cm
RP733S	130 kg	Da 70 a 80 cm	4 ruote	 62 cm 55 cm 58 cm	 65 cm 56 cm 60 cm
RP733M	130 kg	Da 78 a 88 cm	4 ruote	 63 cm 56 cm 60 cm	 65 cm 58 cm 61 cm
RP733L	130 kg	Da 84 a 102 cm	4 ruote	 65 cm 58 cm 62 cm	 68 cm 62 cm 64 cm











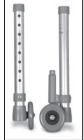



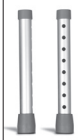

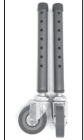

Codici	Portata max	H regolabile ogni 2,5 cm	Puntali/ruote	Base*	Base**
RP741	100 kg	Da 86 a 96 cm	4 ruote 2 con freno	 60 cm 58 cm 54 cm	 61 cm 59 cm 56 cm
RP743	120 kg	Da 85 a 103 cm	4 ruote 2 con rotazione frizionata	 65 cm 60 cm 57 cm	 66 cm 61 cm 59 cm
RP742	130 kg	Da 86 a 103 cm	4 ruote con freno	 65 cm 59 cm 54 cm	 67 cm 60 cm 60 cm
RP748	130 kg	Da 77 a 92 cm	4 ruote con freno	 54 cm 54 cm 54 cm	 54 cm 54 cm 54 cm

\*Ingombro misurato alla regolazione in altezza più bassa.

\*\* Ingombro misurato alla regolazione in altezza più alta.

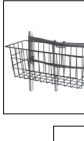
Le misure possono variare di ±1 cm

### 15.1 Parti di ricambio ed accessori

	<b>RV7052</b> Gambe con sistema autobloccante - paio		<b>RV7053</b> Ruote con rotazione frizionata - paio		<b>RV7053D</b> Ruote gemellate con rotazione frizionata Ø 10cm - paio		<b>RV7054-5</b> <b>RV7054-8</b> Ruote piroettanti con 5 o 8 fori Ø 7 cm - paio		<b>RV7055-5</b> <b>RV7055-8</b> Ruote fisse 5 o 8 fori Ø 7 cm - paio
	<b>RV7056-5</b> <b>RV7056-8</b> Gambe complete con 5 o 8 fori - paio		<b>RV7051S</b> Ruote piroettanti 5 fori Ø 8 cm - paio		<b>RV7051F</b> Ruote piroettanti con freno 5 fori Ø 8 cm - paio		<b>RV7121-8</b> Ruote piroettanti 8 fori Ø 10cm - paio		<b>RV7154-8</b> Ruote piroettanti 8 fori Ø 12 cm - paio
	<b>RV7155-8</b> Ruote fisse 8 fori Ø 12cm - paio		<b>RV7015</b> Ruote piroettanti Ø 10 cm - paio Per RP748		<b>RV7016</b> Ruote piroettanti con freno Ø 10 cm - paio Per RP748		<b>RV7035</b> Puntali - paio per RP729		<b>RV7030</b> Puntali colore grigio - paio
	<b>RV7031</b> Ø 28mm Puntali colore nero - paio		<b>RV7045</b> Cestino per deambulatori solo per RP743-749		<b>RV7046</b> Cestino per deambulatori solo per RP742		<b>RV7045N</b> Cestino per deambulatori		
	<b>RV7114</b> Appoggio brachiale - paio		<b>RP758</b> Sedile per RP748						

## 16. GARANZIA

Tutti i prodotti Moretti sono garantiti da difetti di materiale o fabbricazione per un periodo di 2 (due) anni dalla data di vendita del prodotto, salvo eventuali esclusioni e limitazioni specificate di seguito. Questa garanzia non è valida in caso di uso improprio, abuso o modifica del prodotto e per la mancata aderenza alle istruzioni per l'uso. La corretta destinazione d'uso del prodotto è indicata nel manuale d'uso. Moretti non è responsabile di danni risultanti, di lesioni personali o quant'altro causato o relativo all'installazione e/o all'uso dell'apparecchiatura non scrupolosamente conforme alle istruzioni riportate nei manuali per l'installazione, il montaggio e l'uso. Moretti non garantisce i prodotti Moretti contro danni o difetti nelle seguenti condizioni: calamità naturali, operazioni di manutenzione o riparazione non autorizzate, danni derivanti da problemi dell'alimentazione elettrica (dove prevista), utilizzo di parti o componenti non forniti da Moretti, mancata aderenza alle linee guida e istruzioni per l'uso, modifiche non autorizzate, danni di spedizione (diversa dalla spedizione originale da Moretti), oppure dalla mancata esecuzione della manutenzione così come indicato nel manuale. Non sono coperti da questa garanzia componenti usurabili se il danno è da imputarsi al normale utilizzo del prodotto.

## 17. RIPARAZIONI

### 17.1 Riparazione in garanzia

Nel caso in cui un prodotto Moretti presenti difetti di materiale o fabbricazione durante il periodo di garanzia, Moretti valuterà con il cliente se il difetto del prodotto è coperto dalla garanzia. Moretti, a sua insindacabile discrezione, può sostituire o riparare l'articolo in garanzia, presso un rivenditore Moretti specificato o presso la propria sede. I costi della manodopera relativi alla riparazione del prodotto possono essere a carico di Moretti se si determina che la riparazione ricade nell'ambito della garanzia. Una riparazione o sostituzione non rinnova né proroga la garanzia.

### 17.2 Riparazione di un prodotto non coperto dalla garanzia

Si può restituire, affinché sia riparato, un prodotto non coperto dalla garanzia solo dopo aver ricevuto autorizzazione preventiva dal servizio clienti Moretti. I costi della manodopera e di spedizione relativi a una riparazione non coperta dalla garanzia saranno completamente a carico del cliente o del rivenditore. Le riparazioni su prodotti non coperti dalla garanzia sono garantite per 6 (sei) mesi, a decorrere dal giorno in cui si riceve il prodotto riparato.

### 17.3 Prodotti non difettosi

Il cliente sarà avvisato se, dopo avere esaminato e provato un prodotto restituito, Moretti conclude che il prodotto non è difettoso. Il prodotto sarà restituito al cliente e saranno a suo carico i costi di spedizione dovuti alla restituzione.

## 18. RICAMBI

I ricambi originali Moretti sono garantiti per 6 (sei) mesi a decorrere dal giorno in cui si riceve il ricambio.

## 19. CLAUSOLE ESONERATIVE

Salvo quanto specificato espressamente in questa garanzia ed entro i limiti di legge, Moretti non offre nessun'altra dichiarazione, garanzia o condizione, espressa o implicita, comprese eventuali dichiarazioni, garanzie o condizioni di commerciabilità, idoneità per uno scopo particolare, non violazione e non interferenza. Moretti non garantisce che l'uso del prodotto Moretti sarà ininterrotto o senza errori. La durata di eventuali garanzie implicite che possano essere imposte dalle norme di legge è limitata al periodo di garanzia, nei limiti delle norme di legge.

Alcuni stati o paesi non permettono limitazioni sulla durata di una garanzia implicita oppure l'esclusione o la limitazione di danni accidentali o indiretti in relazione a prodotti per i consumatori. In tali stati o paesi, alcune esclusioni o limitazioni di questa garanzia possono non applicarsi all'utente.

**CERTIFICATO DI GARANZIA**

Prodotto \_\_\_\_\_

Acquistato in data \_\_\_\_\_

Rivenditore \_\_\_\_\_

Via \_\_\_\_\_ Località \_\_\_\_\_

Venduto a \_\_\_\_\_

Via \_\_\_\_\_ Località \_\_\_\_\_



Via Bruxelles, 3 - Melegnano 52022 Cavriglia (Arezzo) Tel. +39 055 96 21 11

[www.morettispa.com](http://www.morettispa.com) email: [info@morettispa.com](mailto:info@morettispa.com)**MADE IN P.R.C.**













**MOPEDIA®**

MA RP729x-RP73x-RP74x 07 A\_ENG\_08 2020

**WALKERS**

---

**INSTRUCTION MANUAL**

ENGLISH

## INDEX

1. CODES.....	PAG.3
2. INTRODUCTION.....	PAG.3
3. INTENDED USE.....	PAG.3
4. DECLARATION OF CONFORMITY .....	PAG.3
5. GENERAL WARNINGS .....	PAG.4
6. SYMBOLS .....	PAG.4
7. GENERAL DESCRIPTION .....	PAG.5
8. BEFORE USE .....	PAG.5
9. WARNINGS FOR USE .....	PAG.5
10. ASSEMBLY INSTRUCTIONS RP729X .....	PAG.6
11. HOW TO USE.....	PAG.6
12. MAINTENANCE.....	PAG.7
13. CLEANING AND DISINFECTION .....	PAG.7
13.1 Cleaning.....	pag. 7
13.2 Disinfection.....	pag. 7
14. CONDITION OF DISPOSAL .....	PAG.7
15. TECHNICAL FEATURES.....	PAG.8
15.1 Spare parts and accessories.....	pag. 10
16. WARRANTY .....	PAG.10
17. REPAIR .....	PAG.10
17.1 Warranty repair.....	pag. 10
17.2 Repair not covered by warranty .....	pag. 11
17.3 Non-defective device .....	pag. 11
18. SPARE PARTS.....	PAG.11
19. EXEMPT CLAUSES .....	PAG.11

CE I Class Medical Device

REGULATION (EU) 2017/745 OF THE EUROPEAN PARLIAMENT AND OF THE COUNCIL  
of 5 April 2017 concerning medical devices

## 1. CODES

### Walkers with 4 tips

RP729M-L	Fixed walker adjustable height
RP730M-L	Foldable walker adjustable height
RP747	Foldable walker adjustable height double handgrip
RP749M-L	Foldable walker adjustable height double function

### Walkers with two swivel castors and two tips

RP734	Foldable walker adjustable height, 2 swivel castors and 2 tips
RP735S-M-L	Foldable walker adjustable height, 2 fixed castors and 2 tips
RP737	Foldable walker adjustable height, 2 fixed castors and 2 tips

### Walkers with four castors

RP733S-M-L	Foldable walker adjustable height, 4 swivel castors
RP738	Foldable walker adjustable height, 2 self locking castors and 2 swivel castors
RP741	Foldable walker adjustable height, 4 swivel castors, 2 with brakes
RP748	Demontable walker adjustable height, 2 swivel with brake castors and 2 swivel castors
RP742	Foldable walker with hand brake
RP743	Foldable walker adjustable in height, 2 self locking twin castors, 2 swivel castors

## 2. INTRODUCTION

Thank you for purchasing a MOPEDIA walker by Moretti S.p.A. This user's manual provides some suggestions as how to correctly use the product you have chosen and gives some valuable advice for your safety. Please read through the manual carefully before using the product. Should you have any queries, please contact your retailer for advice and assistance.

## 3. INTENDED USE

The Mopedia by Moretti walkers are devices to be used with two arms and are intended for people with movement difficulties.

### WARNING!



- Do not use the product for a purpose not indicated in this manual;
- Moretti S.p.A declines all responsibilities for any consequences resulting from an incorrect use of this product and from unauthorized alteration to the frame of the product;
- The manufacturer reserves the right to change the information contained in this document without previous notice.

## 4. DECLARATION OF CONFORMITY

Moretti S.p.A. declares under its sole responsibility that the product made and traded by Moretti S.p.A. and belonging to the group of WALKERS MOPEDIA complies with the provisions of the regulation 2017/745 on MEDICAL DEVICES of 5 April 2017.

For this purpose, Moretti S.p.A. guarantees and declares under its sole responsibility what follows:

1. The devices satisfy the requirements of general safety and performance requested by the Annex I of regulation 2017/745 as laid down by the Annex IV of the above mentioned regulation.
2. The devices ARE NOT MEASURING INSTRUMENTS.
3. The devices ARE NOT MADE FOR CLINICAL TESTS.
4. The devices are packed in NON-STERILE BOX.
5. The devices belong to class I in accordance with the provisions of Annex VIII of the above mentioned regulation
6. Moretti S.p.A. provides to the Competent Authorities the technical documentation to prove the conformity to the 2017/745 regulation, for at least 10 years from the last lot production.

**Note:** Complete product codes, the manufacturer registration code (SRN), the UDI-DI code and any references to used regulations are included in the EU declaration of conformity that Moretti S.p.A. releases and makes available through its channels.

### 5. GENERAL WARNINGS

- READ carefully the entire manual before using the device;
- Advise with physician or therapist to determinate the correct adjustment and the correct use of the walker;
- Make sure that the product is delivered complete and keep it packed away from heat sources;
- SERVICE LIFE- the device use limit is defined by the wear of the parts;
- DO NOT allow children to play or operate the device.
- The user and/or the patient will have to report any serious accident that have occurred related the device to the manufacturer and appropriate authority of the State which the user and/or patient belongs to.

### 6. SYMBOLS



Product code



Unique Device Identification



CE mark



Manufacturer



Batch Lot



Read the instruction manual



Medical Device



Conditions of disposal

## 7. GENERAL DESCRIPTION

The walkers MOPEDIA are realized in lightweight anodized aluminum tubing with padded handles, non-slip rubber tips and/or swivel castors and/or fixed castors. They are height adjustable every 2,5 cm. These devices facilitate people movement with limited static equilibrium and / or dynamic, increasing the amplitude to the supporting base. They provide support in situations of weakness and/or paralysis of the lower limbs. Helps to download on the arms part of the weight of the person, where it is required a limitation of the load on one or both lower limbs.



### 7.1 To adjust height

To adjust the height, press the push button and slide the cane to the desired height. Be sure the push button is fully protruded through the desired hole when finished. Repeat described procedure for each leg, at the end, check all four legs have the same height.

## 8. BEFORE USE

- Always check that the brakes work before using the walker, if available;
- Do not use the walker if it is damaged or malfunctioning please contact retailer for repairing;
- Check if the frame is damaged in order to guarantee a safe use for people and things;
- Users must travel along pedestrian paths and not on busy roads;
- Pay attention to the possibility of injury from entrapment; avoid placing your fingers between the moving parts of the walker. Pay attention closing and opening the walker.

## 9. WARNINGS FOR USE

This device provides greater stability, support and safety while moving. In any case, it can not be used by people with a functionality of the hand and / or arm visibly weak and even by people with balance problems. The walker can be used both outside and inside. We recommend using only on surfaces on which all four legs touch the ground. It should not be used on rocky terrain or on inclined surfaces because the walker can become unstable. The device is not designed for the transport of persons or other material

- Use extra caution on wet and slippery surfaces;
- DO NOT use with patient who exceed the weight indicated in the product label and in the technical features chapter of the present manual;
- Avoid use on slopes greater than 10 degrees and turn around on uphill or downhill the disabled must be assisted by an operator
- Avoid to leave the device in contact with water for long periods of time;
- Periodically check its sturdiness, the stability and the rubber tips are in good conditions. Replace them once worn out;
- In case of doubts about use, adjustment or maintenance, contact your dealer;
- Keep it away from children to avoid any possible risks;

## 10. ASSEMBLY INSTRUCTIONS RP729X

Parts list

1. Main Frame (1pc)
2. Legs (2pcs)
3. Bent tube (1pc)
4. Assembly Kit (1pc)

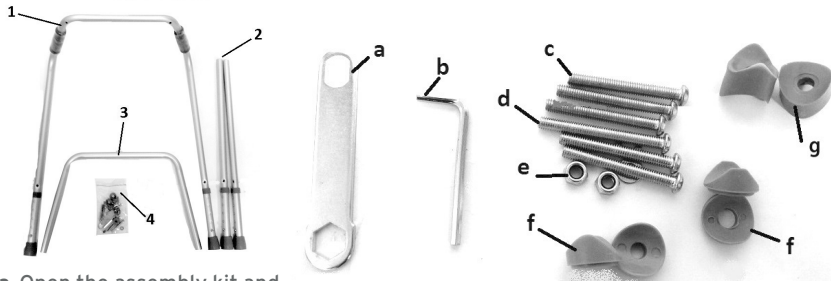

- a. Open the assembly kit and start the assembly taking the main frame (1)
- b. Assemble on the main frame (1) : the legs (2), the saddle washers (f) and the short screws (c). Do not tighten completely the screws.
- c. Assemble on the front side of the main frame (1): the bent tube (2) with saddle washers (g), the long screws (d), nuts and washers (e). Do not tighten completely the screws.
- d. Assemble on the main frame (1): the bent tube (2) with the saddle washers (f) and the short screws (c). Do not tighten completely the screws.
- e. Tighten all screws, the walker is now ready to use. (Look the picture below)

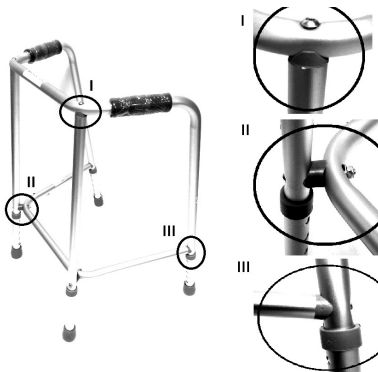

## 11. HOW TO USE

**Note:** Refer to the safety instructions in this manual. Use the walker as aid device for walking. To do this use the two handles and push forward the aid thus obtaining a support convenient and reliable for walking.

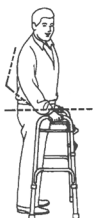

With your arm extended down, handgrips should be at your wrist height. With your hand placed on the handgrip, your elbow should be flexed by 20° - 30°.



**WARNING!**

- Pay attention on the presence of electrical wires, wet surfaces, rugs, toys or debris, furniture, little steps and gaps in floors. Do not use the walker on stairs or escalators.



1. To transfer the patient from the wheelchair to the walker, be sure castors of the wheelchair and walker if available are locked.



**WARNING!**

- For the transfer and the first steps get help by an operator.



2. a) Walkers with tips: to walk lift it up and place it comfortably in front of you, ensuring all four legs are on the floor. Walk carefully taking, one step at a time.

- b) Walkers with castors: to walk push it comfortably in front of you and ensuring all four legs even the one with castors are on the floor. Walk carefully taking, one step at a time.

**Note:** The walker must always be grasped from the handles.



Do not push the walker too far away from the body. This can cause falls and inadequate loads.

**12. MAINTENANCE**

The Mopedia devices by MORETTI are checked carefully and supplied with EC mark, once launched on the market. For patient and physician's safety we recommend to let check the device by the manufacturer or by laboratory authorized every 2 years. For periodic inspection we mean an examination of the following parts:

- The walker frame and the connecting parts;
- Check mounting and operation of the castors with its brake;
- Check all the welded points;
- Check the wear of the tips, where present;

In case of repair must be used only approved parts and accessories.

**13. CLEANING AND DISINFECTION**

**13.1 Cleaning**

Use only a damp cloth to remove dust, use a damp cloth with a mild soap to remove more difficult dirt. Dry thoroughly before use. Never use water with temperature above 30°C. Never use jet water or steam washing machine.

**13.2 Disinfection**

If you need to disinfect the device use a common disinfectant cleaner.











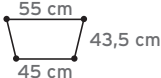
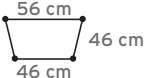
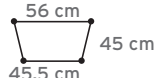
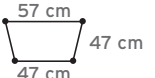
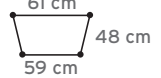
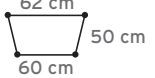
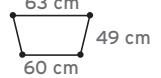
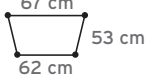

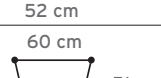

**Note:** Never use acids, alkalis or solvents such as acetone.

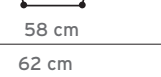
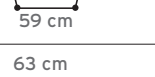
**14. CONDITION OF DISPOSAL**



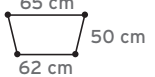

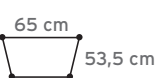
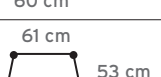







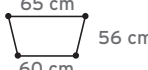

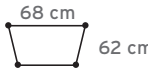

In case of disposal of the device don't use the common container for municipal waste. We recommend to dispose the device in the appropriate disposal areas for recycling.

## 15. TECHNICAL FEATURES

Codes	Max user's weight	Adjustable height every 2,5 cm	Tips/castors	Base*	Base**
RP729M	110 Kg	From 76 to 86 cm	4 tips	 43,5 cm	 46 cm
RP729L		From 86 to 96 cm		 45 cm	 47 cm
RP730M	110 Kg	From 77 to 87 cm	4 tips	 48 cm	 50 cm
RP730L		Da 83 a 101 cm		 49 cm	 53 cm
RP749M	130 kg	From 77,5 to 87,5 cm	4 tips	 47,5 cm	 49 cm
RP749L		From 83,5 to 101,5 cm		 47,5 cm	 52 cm
RP747	130 kg	From 71 to 89 cm	4 tips	 51 cm	 52 cm
RP735S	130 kg	From 68,5 to 78,5 cm	2 castors and 2 tips	 46 cm	 48 cm
RP735M	130 kg	From 76 to 86 cm	2 castors and 2 tips	 48 cm	 50 cm
RP735L	130 kg	From 83 to 101 cm	2 castors and 2 tips	 49,5 cm	 53,5 cm
RP737	130 kg	From 84 to 102 cm	2 castors and 2 tips	 53 cm	 57 cm
RP734	130 kg	From 84 to 102 cm	2 castors and 2 tips	 50 cm	 54 cm



Codes	Max user's weight	Adjustable height every 2,5 cm	Tips/castors	Base*	Base**
RP738	130 kg	From 84 to 102 cm	4 castors		
RP733S	130 kg	From 70 to 80 cm	4 castors		
RP733M	130 kg	From 78 to 88 cm	4 castors		
RP733L	130 kg	From 84 to 102 cm	4 castors		
RP741	100 kg	From 86 to 96 cm	4 castors 2 with brakes		
RP743	120 kg	From 85 to 103 cm	4 castors 2 glide brake		
RP742	130 kg	From 86 to 103 cm	4 castors with brakes		
RP748	130 kg	From 77 to 92 cm	4 castors with brakes		

\*Dimensions measured at the lower height adjustment.

\*\*Dimensions measured at the higher height adjustment.

The measures may change ±1 cm

## 15.1 Spare parts and accessories

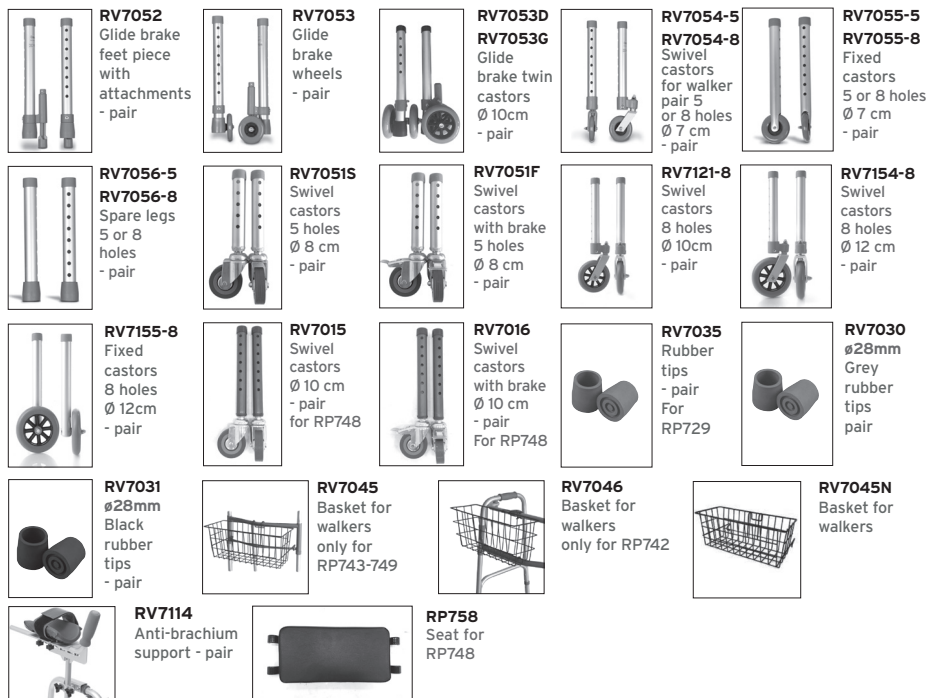

## 16. WARRANTY

Moretti products are guaranteed from material or manufacturing faults for a period of (two) 2 years from the purchasing date, subject to any limitations and exclusions specified below. The warranty does not apply in case of damages caused by improper use, abuse or modification of the product, and the warranty will not be valid if the instructions for use are not strictly followed. The correct intended use of the device is specified in this manual. Moretti is not responsible for damages resulting from personal injury or otherwise caused by or in relation to wrong installation or improper use. Moretti Moretti does not guarantee the products against damage or defects in the following conditions: natural disaster, not authorized maintenance or repair, damage due to power supply problems (where provided) use of spare parts not supplied by Moretti, improper use, not authorized alteration, shipping damage (other than original shipment by Moretti), or in case of insufficient maintenance as indicated in the manual. The warranty doesn't cover components subject to wear and tear during the correct use of the device.

## 17. REPAIR

### 17.1 Warranty repair

In the event that a product Moretti to be defective in material or manufacturing faults during the warranty period, Moretti will confirm with customer if the fault can be covered from warranty. Moretti, in its sole discretion, can repair or replace the item under warranty at a Moretti dealer or at Moretti location. The labor cost for the repair may be charged to Moretti if the repair is covered by warranty. Repair or replacement does not renew or extend the warranty

### 17.2 Repair not covered by warranty

A product not covered by warranty can be returned for repairing only after receiving prior authorization from Moretti customer service. The labor and shipping costs for a repair not covered by warranty will be fully borne by the customer or dealer. Repairs of products not covered by warranty are warranted for six (6) months from the date you receive the product repaired.

### 17.3 Non-defective device

The customer will be informed if, after having examined and tested returned product, Moretti claims that the product is not defective. In this case the good will be returned to the customer, all shipping costs will be paid by customer .

## 18. SPARE PARTS

The original Moretti spare parts are guaranteed for 6 (six) months from the receiving date.

## 19. EXEMPT CLAUSES

Except as expressly specified in this warranty and within the limits of the law, Moretti does not offer any representation, warranty or condition, express or implied, including any representations, warranties or conditions of merchantability, fitness for a particular purpose, non-infringement and interference. Moretti does not warrant that the use of the product Moretti will be uninterrupted or error free. The duration of any implied warranties that may be imposed by law are limited to the warranty period, within the limits of the law. Some states do not allow limitations on how long an implied warranty lasts or the exclusion or limitation of incidental or consequential damages in connection with products for consumers. In such states or countries, certain disclaimers and limitations of this warranty may not apply to you. This warranty is subject to change without notice.



## WARRANTY CERTIFICATE

Product \_\_\_\_\_

Purchased on (date) \_\_\_\_\_

Retailer \_\_\_\_\_

Address \_\_\_\_\_ Town/city \_\_\_\_\_

Sold to \_\_\_\_\_

Address \_\_\_\_\_ Town/city \_\_\_\_\_



Via Bruxelles, 3 - Meleto 52022 Cavriglia (Arezzo) Tel. +39 055 96 21 11

[www.morettispa.com](http://www.morettispa.com) email: [info@morettispa.com](mailto:info@morettispa.com)

MADE IN P.R.C.





**MOPEDIA®**

MA RP729x-RP73x-RP74x 07 A\_ESP\_08 2020

**ANDADORES BAJOS**

**MANUAL DE INSTRUCCIONES**

ESPAÑOL

## ÍNDICE

<b>1. CÓDIGOS.....</b>	<b>PAG.3</b>
<b>2. INTRODUCCIÓN.....</b>	<b>PAG.3</b>
<b>3. FINALIDAD.....</b>	<b>PAG.3</b>
<b>4. DECLARACIÓN UE DE CONFORMIDAD.....</b>	<b>PAG.4</b>
<b>5. ADVERTENCIAS GENERALES.....</b>	<b>PAG.4</b>
<b>6. SÍMBOLOS.....</b>	<b>PAG.4</b>
<b>7. DESCRIPCIÓN GENERAL.....</b>	<b>PAG.5</b>
7.1 Regulación altura .....	pag. 5
<b>8. ANTES DE CADA USO.....</b>	<b>PAG.5</b>
<b>9. ADVERTENCIAS PARA EL USO.....</b>	<b>PAG.5</b>
<b>10. INSTRUCCIONES DE MONTAJE POR RP729X.....</b>	<b>PAG.6</b>
<b>11. INSTRUCCIONES DE USO.....</b>	<b>PAG.6</b>
<b>12. MANTENIMIENTO.....</b>	<b>PAG.7</b>
<b>13. LIMPIEZA Y DESINFECCIÓN.....</b>	<b>PAG.7</b>
13.1 Limpieza .....	pag. 7
13.2 Desinfección .....	pag. 8
<b>14. CONDICIONES DE ELIMINACIÓN.....</b>	<b>PAG.8</b>
<b>15. CARACTERÍSTICAS TÉCNICAS.....</b>	<b>PAG.8</b>
15.1 Repuestos y accesorios.....	pag. 10
<b>16. GARANTÍA.....</b>	<b>PAG.10</b>
<b>17. REPARACIONES.....</b>	<b>PAG.10</b>
17.1 Reparaciones en garantía.....	pag. 10
17.2 Reparación de un producto no cubierto por garantía .....	pag. 11
17.3 Productos no defectuosos .....	pag. 11
<b>18. REPUESTOS.....</b>	<b>PAG.11</b>
<b>19. CLÁUSULAS EXONERATIVAS.....</b>	<b>PAG.11</b>

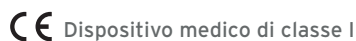

REGOLAMENTO (UE) 2017/745 DEL PARLAMENTO EUROPEO E DEL CONSIGLIO  
del 5 aprile 2017 relativo ai dispositivi medici

## 1. CÓDIGOS

### Andadores con 4 conteras

RP729M-L	Andador fijo, altura ajustable
RP730M-L	Andador plegable mediante 1 botón - altura ajustable
RP747	Andador plegable empuñadura doble altura ajustable
RP749S-M-L	Andador plegable doble función fijo/articulado - altura ajustable

### Andadores con 2 ruedas y 2 conteras

RP734	Andador plegable altura ajustable 2 ruedas giratorias
RP735S-M-L	Andador plegable altura ajustable 2 ruedas fijas
RP737	Andador plegable altura ajustable 2 conteras auto-bloqueantes

### Andadores con 4 ruedas

RP733S-M-L	Andador plegable ajustable en altura - ruedas giratorias
RP738	Andador plegable ajustable en altura 2 ruedas auto-bloqueantes
RP741	Andador plegable ajustable en altura, 4 ruedas giratorias, 2 con freno
RP748	Andador desmontable, altura ajustable, 2 ruedas giratorias con freno y 2 ruedas giratorias
RP742	Andador plegable, altura ajustable, freno manual
RP743	Andador plegable ajustable en altura con 2 ruedas gemelas traseras a rotación friccionada

## 2. INTRODUCCIÓN

Gracias por haber elegido un andador de la línea MOPEDIA fabricada por Moretti S.p.A. Su diseño y calidad garantizan el máximo confort, la máxima seguridad y fiabilidad. Los andadores MOPEDIA de MORETTI S.p.A. han sido diseñados y fabricados para satisfacer todas sus exigencias de uso práctico y correcto de los mismos. Este manual de instrucciones contiene algunas sugerencias que le permitirán usar correctamente el equipo que Ud. ha elegido así como valiosos consejos para su seguridad. Se aconseja leer atentamente todo el manual antes de utilizar el andador. En caso de dudas contacte con el distribuidor, que estará en condiciones de brindarle ayuda y consejos.

## 3. FINALIDAD

Los andadores MOPEDIA by Moretti son ayudas accionadas por los dos brazos. Ayudan la movilidad de personas con dificultad de deambulación.



### ¡ATENCIÓN!

- Está prohibido utilizar el producto con fines diferentes de aquel definido en este manual.
- Moretti S.p.A. declina toda responsabilidad por los daños provocados a causa de un uso incorrecto del dispositivo o por un uso diferente al indicado en el presente manual.
- El fabricante se reserva el derecho de aportar modificaciones al dispositivo y a este manual sin aviso previo, con propósitos de mejora.

#### 4. DECLARACIÓN UE DE CONFORMIDAD

Moretti S.p.A. declara bajo su exclusiva responsabilidad que los productos fabricados e introducidos en el mercado por la misma MORETTI Spa que hacen parte de la familia ANDADORES BAJOS - MOPEDIA son conformes con las disposiciones del reglamento 2017/745 sobre los PRODUCTOS SANITARIOS del 5 Abril 2017. Para ello, MORETTI Spa. declara bajo su exclusiva responsabilidad los siguientes puntos:

1. Los productos en cuestión satisfacen los requisitos generales de seguridad y prestación como requerido por el anexo 1 del reglamento 2017/745 como prescrito por el anexo IV del mismo reglamento.
2. Los productos en cuestión NO SON INSTRUMENTOS DE MEDICIÓN.
3. Los productos en cuestión NO ESTÁN DESTINADOS A INVESTIGACIONES CLÍNICAS.
4. Los productos en cuestión se comercializan en presentación NO ESTÉRIL.
5. Los productos en cuestión deben considerarse de clase I en conformidad a lo establecido en el anexo VIII del mismo Reglamento.
6. MORETTI S.p.A. mantiene y pone a disposición de las Autoridades Competentes, por 10 años desde la fecha de fabricación del último lote, la documentación técnica que comprueba la conformidad con el Regl6.

**Nota:** Los códigos completos de los productos, el código de registración del Fabricante (SRN), el código UDI-DI de base y eventuales referencias a normas utilizadas se encuentran en la Declaración de Conformidad UE que MORETTI SPA emite y mete a disposición a través de sus canales.

#### 5. ADVERTENCIAS GENERALES

- Para utilizar este equipo correctamente se refieran a este manual
- Para utilizar este equipo correctamente se consulten con su médico o terapeuta
- Averiguar que el producto entregado no tenga daños y mantenerlo embalado alejado de fuentes de calor
- La vida del producto depende del desgaste de partes que no se pueden reparar e/o sustituir
- Tener cuidado a la presencia de niños
- El usuario y/o el paciente tendrá que señalar al fabricante y al Autoridad competente del Estado miembro en el cual el usuario/paciente está establecido cualquier incidencia grave que se verifique en relación al dispositivo.

#### 6. SÍMBOLOS



Código producto



Identificación única de productos



Marcado CE



Fabricante



Lote de producción



Leer el manual de instrucciones



Producto sanitario



Condiciones de eliminación 2017/45



## 7. DESCRIPCIÓN GENERAL

Los andadores MOPEDIA están fabricados en aluminio anodizado ligero, son plegables o desmontables (RP729), tienen empuñaduras acolchadas y/o conteras antideslizantes y ruedas fijas o giratorias. Altura ajustable cada 2.5 cm. Los dispositivos antes mencionados facilitan el movimiento de personas con equilibrio estático y/o dinámico limitado, aumentando el ancho de la base de apoyo. Brindan apoyo en situaciones de hipostenia y/o paresia de las extremidades inferiores. Ayuda a descargar parte del peso de la persona en los brazos, cuando se requiere una limitación de carga en una o ambas extremidades inferiores.

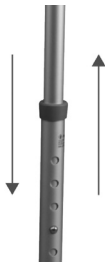

### 7.1 Regulación altura

Presione el botón de resorte y retire el tubo llevándolo a los agujeros en correspondencia de la altura deseada y la maniobrabilidad subjetiva del propio paciente. Vuelva a colocar el tope en el agujero para bloquear el tubo y asegúrese de que el tope esté bien insertado antes de usar el dispositivo. Verifique que las cuatro patas estén a la misma altura. Capacidad máxima 130 kg, modelo 110 kg RP729x, modelo 60 kg niños (RP731 y RP736).

## 8. ANTES DE CADA USO

- Compruebe siempre que los frenos funcionen (si están presentes) antes de usar el andador;
- No use el andador si está dañado o funciona mal;
- Contacte con el revendedor para las reparaciones;
- Los usuarios deben moverse en rutas peatonales y no en carreteras transitadas;
- Tener en cuenta la posibilidad de lesiones por atrapamiento; evite colocar sus dedos entre las partes móviles del andador. Preste especial atención al cerrar y abrir el andador.

## 9. ADVERTENCIAS PARA EL USO

Este dispositivo proporciona mayor estabilidad, soporte y seguridad en el andar. En cualquier caso, no puede ser utilizado por personas con funcionalidades de mano y/o brazo visiblemente débiles y tampoco por personas con problemas de equilibrio. El andador se puede usar tanto en exteriores como en interiores. Recomendamos usarlo solo en superficies donde las cuatro patas toquen el suelo. No debe usarse en terreno rocoso o en planos inclinados porque el andador podría ser inestable. El dispositivo no está diseñado para el transporte de personas u otro material.

- Usar con precaución en superficies mojadas y resbaladizas.
- No exceda el peso máximo del paciente indicado en la etiqueta del producto y en el capítulo de características técnicas de este manual;
- Evite usar en pendientes mayores de 10 (grados). Para girar en un plano inclinado, la persona discapacitada debe ser asistida por un operador;
- Compruebe periódicamente la estabilidad y robustez del producto, así como el estado de las conteras de soporte y de las ruedas. Sustitúyelas una vez que estén desgastadas;
- En caso de dudas sobre el utilizó, la regulación, el mantenimiento del producto, contacte con el revendedor;
- Para evitar cualquier riesgo, mantenga el dispositivo fuera del alcance de los niños.

## 10. INSTRUCCIONES DE MONTAJE POR RP729X

Lista de las partes

1. Estructura de soporte (1 ud)
2. Patas (2 uds)
3. Tubo doblado (1 ud)
4. Kit de montaje (1 ud)

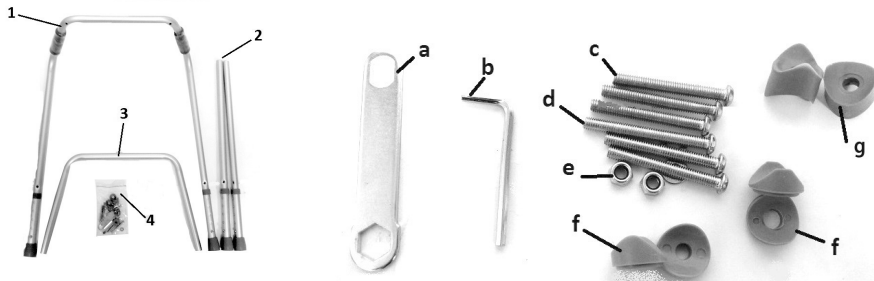

- a. Abrir el kit de montaje e iniciar tomando la estructura de soporte (1)
- b. Ensamble las patas (2) con las arandelas (g) y los tornillos CORTOS (c) en la estructura de soporte (1). No apretar completamente los tornillos.
- c. Ensamble el tubo doblado (3) con las arandelas (h), los tornillos LARGOS (d) y la tuerca con la arandela (e) en la estructura de soporte (1). No apretar completamente los tornillos.
- d. Ensamble el tubo doblado (3) con las arandelas (f) y los tornillos CORTOS (c) en la estructura de soporte (1). No apretar completamente los tornillos.
- e. Apretar bien todos los tornillos, el andador está listo para el uso. (Ver foto abajo).

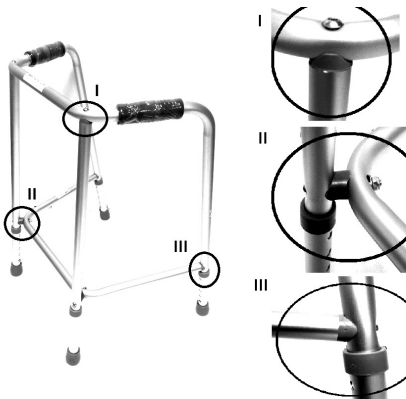

## 11. INSTRUCCIONES DE USO

**NOTA:** Consulte las advertencias de seguridad en este manual de instrucciones. Use el andador como ayuda para caminar. Para hacer esto, use las dos asas y empuje el andador hacia adelante, obteniendo así un soporte práctico y confiable para caminar.

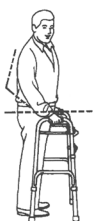

Con el brazo extendido, el empuñadura del andador debe estar a la altura de la muñeca. Con la mano apoyada en el empuñadura el codo debe doblarse entre 20 ° y 30 °.



**¡ATENCIÓN!**

En presencia de cables eléctricos en el suelo, piso mojado, alfombras, juguetes u otros obstáculos, muebles, escalones y pisos irregulares, no use el andador, ni para subir o bajar escaleras o escaleras mecánicas.



1. Para transferir al paciente de la silla de ruedas al andador, asegúrese de que las ruedas de la silla de ruedas y del andador (si las tiene) estén bloqueadas.



**¡ATENCIÓN!**

Para la transferencia y los primeros pasos, pedir ayuda a un operador.



a) Andadores con conteras: para caminar con el andador, levántelo y colóquelo comodamente frente a usted, asegurándose que las cuatro patas estén bien apoyadas en el suelo. Caminar con cuidado haciendo un paso a la vez.

b) Andadores con ruedas: para caminar con el andador, empújelo hacia adelante, asegurándose que las cuatro patas, incluso las con ruedas, estén bien apoyadas en el suelo. Caminar con cuidado, haciendo un paso a la vez.

**Nota:** Empuñar el andador siempre en las empuñaduras.



**¡ATENCIÓN!**

No empujar el andador demasiado lejano del cuerpo, ésto podría causar caídas y cargos inadecuados. cadute e carichi inadeguati.

**12. MANTENIMIENTO**

Los accesorios de la línea MOPEDIA by Moretti son controlados cuidadosamente antes de ponerlos en el mercado y tienen marcado CE. Se recomienda hacer controlar el dispositivo por personal cualificado cada 2 años, para asegurarse la idoneidad al uso. La inspección periódica es un examen de las siguientes partes:

- Estructura de soporte del andador y sus conexiones;
- Controlar montaje y funcionamiento de las ruedas y frenos (donde haya frenos);
- Mirar los puntos de soldadura;
- Averiguar el desgaste de las conteras.

En caso de reparación se recomienda utilizar recambios y accesorios originales solamente.

**13. LIMPIEZA Y DESINFECCIÓN**

**13.1 Limpieza**

Utilizar exclusivamente un paño húmedo para quitar el polvo, y un paño húmedo con jabón neutro para eliminar la suciedad más dura. Secar bien antes del uso. La temperatura del agua

no tiene que ser superior a los 30°C. No utilice lavadoras con chorro de agua y/o vapor.

### 13.2 Desinfección











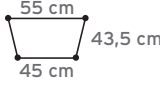
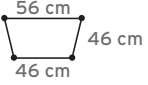
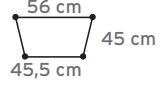
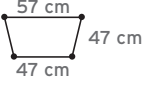

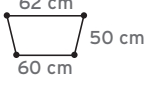

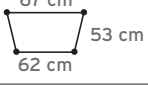
Si es necesario desinfectar el producto, utilizar un normal detergente desinfectante.





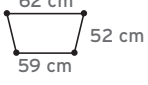



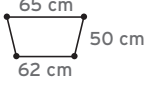













**Nota:** No utilizar productos ácidos, alcalinos o solventes como acetona o diluyente.

## 14. CONDICIONES DE ELIMINACIÓN

No eliminar el producto junto con los desechos sólidos urbanos. Para la eliminación del producto, entregarlo en una isla ecológica municipal en vistas del posterior reciclado de los materiales.

## 15. CARACTERÍSTICAS TÉCNICAS

Código	Peso max	Hajustable cada 2,5cm	Conteras/ruedas	Base*	Base**
RP729M	110 Kg	De 76 a 86 cm	4 conteras		
RP729L		De 86 a 96 cm			
RP730M	110 Kg	De 77 a 87 cm	4 conteras		
RP730L		De 83 a 101 cm			
RP749M	130 kg	De 77,5 a 87,5 cm	4 conteras		
RP749L		De 83,5 a 101,5 cm			
RP747	130 kg	De 71 a 89 cm	4 conteras		
RP735S	130 kg	De 68,5 a 78,5 cm	2 ruedas y 2 conteras		
RP735M	130 kg	De 76 a 86 cm	2 ruedas y 2 conteras		











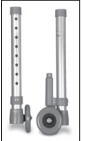



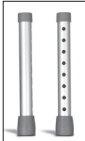



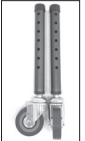

Código	Peso max	Hajustable cada 2,5cm	Conteras/ruedas	Base*	Base**
RP735L	130 kg	De 83 a 101 cm	2 ruedas y 2 conteras	 63 cm 60 cm 49,5 cm	 65 cm 62 cm 53,5 cm
RP737	130 kg	De 84 a 102 cm	2 ruedas y 2 conteras	 61 cm 62 cm 53 cm	 64 cm 65 cm 57 cm
RP734	130 kg	De 84 a 102 cm	2 ruedas y 2 conteras	 61 cm 60 cm 50 cm	 63 cm 61,5 cm 54 cm
RP738	130 kg	De 84 a 102 cm	4 ruedas	 66 cm 62 cm 55 cm	 69 cm 64 cm 59 cm
RP733S	130 kg	De 70 a 80 cm	4 ruedas	 62 cm 58 cm 55 cm	 65 cm 60 cm 56 cm
RP733M	130 kg	De 78 a 88 cm	4 ruedas	 63 cm 60 cm 56 cm	 65 cm 61 cm 58 cm
RP733L	130 kg	De 84 a 102 cm	4 ruedas	 65 cm 62 cm 58 cm	 68 cm 64 cm 62 cm
RP741	100 kg	Da 86 a 96 cm	4 ruedas 2 con freno	 60 cm 58 cm 54 cm	 61 cm 59 cm 56 cm
RP743	120 kg	Da 85 a 103 cm	4 ruedas 2 con rotación friccionada	 65 cm 60 cm 57 cm	 66 cm 61 cm 59 cm
RP742	130 kg	Da 86 a 103 cm	4 ruedas con freno	 65 cm 59 cm 54 cm	 67 cm 60 cm 60 cm
RP748	130 kg	Da 77 a 92 cm	4 ruedas con freno	 54 cm 54 cm 54 cm	 54 cm 54 cm 54 cm

\*Medidas referidas a la regulación de altura la más baja.

\*\*Medidas referidas a la regulación de altura la más alta.

Las medidas pueden variar de  $\pm 1$  cm

### 15.1 Repuestos y accesorios

	<b>RV7052</b> Patas con conteras auto-bloqueantes - par		<b>RV7053</b> Ruedas con rotación friccionada - par		<b>RV7053D</b> 2 ruedas gemelas a rotación friccionada $\varnothing$ 10cm - par		<b>RV7054-5</b> <b>RV7054-8</b> Ruedas giratorias 5 o 8 agujeros $\varnothing$ 7 cm - par		<b>RV7055-5</b> <b>RV7055-8</b> Ruedas fijas 5 o 8 agujeros $\varnothing$ 7 cm - par
	<b>RV7056-5</b> <b>RV7056-8</b> Patas completa 5 o 8 agujeros - par		<b>RV7051S</b> Ruedas giratorias 5 agujeros $\varnothing$ 8 cm - par		<b>RV7051F</b> Ruedas giratorias con freno 5 agujeros $\varnothing$ 8 cm - par		<b>RV7121-8</b> Ruedas giratorias 8 agujeros $\varnothing$ 10cm - par		<b>RV7154-8</b> Ruedas giratorias 8 agujeros $\varnothing$ 12 cm - par
	<b>RV7155-8</b> Ruedas fijas 8 agujeros $\varnothing$ 12cm - par		<b>RV7015</b> Ruedas giratorias $\varnothing$ 10 cm - par Para RP748		<b>RV7016</b> Ruedas giratorias con freno $\varnothing$ 10 cm - par Para RP748		<b>RV7035</b> Conteras - par Para RP729		<b>RV7030</b> $\varnothing$ 28mm Conteras de color gris - par
	<b>RV7031</b> $\varnothing$ 28mm Conteras de color negro - par		<b>RV7045</b> Cesta para andadores solo para RP743-749		<b>RV7046</b> Cesta para andadores solo para RP742		<b>RV7045N</b> Cesta para andadores		
	<b>RV7114</b> Apoyo braquial - par		<b>RP758</b> Asiento para RP748						

### 16. GARANTÍA

Todos los productos MORETTI tienen una garantía de 2 años de la fecha de venta por defectos de fabricación o de material. La garantía no se aplica en caso de daños causados por uso inadecuado, abusos, alteraciones y en caso de que no se respeten las instrucciones de uso. La finalidad correcta del producto está indicada en el manual de instrucciones. Moretti no es responsable por los daños provocados de una instalación o uso del dispositivo no conforme con las instrucciones que se encuentran en el manual para la instalación, el montaje y el uso. Moretti no garantiza los productos Moretti por daños o defectos en las condiciones siguientes: calamidades, operaciones de mantenimiento o reparación no autorizadas, daños causados por el alimentación eléctrica (donde está), uso de piezas no suministradas por Moretti, por no respetar las instrucciones de uso, modificaciones no autorizadas, daños de expedición (distintas de las expediciones originales de Moretti), falta del mantenimiento indicado por el manual. No están cubiertas por la garantía piezas sujetas al deterioro si el daño es causado por normal uso del producto.

### 17. REPARACIONES

#### 17.1 Reparaciones en garantía

En caso de que un producto Moretti tenga defectos de material o fabricación durante del periodo de la garantía, Moretti evaluará con el cliente si el defecto del producto está cubierto por la garantía. Moretti, según su incontestable criterio, puede substituir o reparar el artículo en garantía a través de un distribuidor Moretti o en sus mismas oficinas. Los gastos de la mano de obra por la reparación del producto pueden ser a cargo de Moretti si el producto está cubierto por la garantía. Una reparación o substitución no renueva ni extiende la garantía.

### 17.2 Reparación de un producto no cubierto por garantía

Prevía autorización de Moretti se puede devolver por reparación un producto que no esté más cubierto por la garantía. Los gastos de la mano de obra y de los portes relativos a una reparación que no esté cubierta por la garantía son completamente a cargo del cliente o distribuidor. Las reparaciones de productos no en garantía se garantizan por los 6 meses siguientes de la fecha de entrega del producto reparado.

### 17.3 Productos no defectuosos

Moretti avisará al cliente si después de probar el producto constatará que no es defectuoso. Moretti devolverá el producto al cliente que se cargará de los gastos de los portes para la devolución.

### 18. REPUESTOS

Los repuestos originales Moretti son garantizados por 6 meses a partir de la fecha de entrega del repuesto.

### 19. CLÁUSULAS EXONERATIVAS

Salvo indicación expresada en esta garantía y dentro de los límites de la ley, Moretti no ofrece ninguna declaración, garantía o condición, expresa o implícita, incluyendo todas las declaraciones, garantías o condiciones de comerciabilidad, adecuación para un propósito particular, no infracción y no interferencia. Moretti no garantiza que el uso del producto Moretti será sin interrupción o sin errores. La duración de cualquier garantía implícita que se puede imponer por ley se limita al período de garantía, dentro de los límites de la ley.

Algunos estados no permiten limitaciones en la duración de una garantía implícita o la exclusión o limitación de daños incidentales o consecuentes relacionados con productos para consumidores finales. En esos estados o países, algunas exclusiones o limitaciones de esta garantía pueden no aplicarse al usuario



## CERTIFICADO DE GARANTÍA

Producto \_\_\_\_\_

Fecha de compra \_\_\_\_\_

Distribuidor \_\_\_\_\_

Calle \_\_\_\_\_ Localidad \_\_\_\_\_

Vendido a \_\_\_\_\_

Calle \_\_\_\_\_ Localidad \_\_\_\_\_



Via Bruxelles, 3 - Melegnano 20122 Cavriaglia (Arezzo) Tel. +39 055 96 21 11

[www.morettispa.com](http://www.morettispa.com) email: [info@morettispa.com](mailto:info@morettispa.com)

MADE IN P.R.C.

**MORETTI S.P.A.**

Via Bruxelles, 3 - Meleto  
52022 Cavriglia (Arezzo)

Tel. +39 055 96 21 11  
Fax. +39 055 96 21 200

[www.morettispa.com](http://www.morettispa.com)  
[info@morettispa.com](mailto:info@morettispa.com)