

SKEMA[®]FORM

MA M137XX - M138XX - M139XX 02 A _ ITA_09-2020

**LETTINO DA VISITA
MEDICA PROFESSIONALE**

MANUALE DI ISTRUZIONI



INDICE

| | |
|--|---------------|
| 1. CODICI..... | PAG.3 |
| 2. INTRODUZIONE..... | PAG.3 |
| 3. DESTINAZIONE D'USO..... | PAG.3 |
| 4. DICHIARAZIONE DI CONFORMITÀ UE | PAG.3 |
| 4.1 Norme e direttive di riferimento..... | pag. 4 |
| 5. AVVERTENZE GENERALI | PAG.4 |
| 6. SIMBOLOGIA UTILIZZATA..... | PAG.4 |
| 7. DESCRIZIONE GENERALE | PAG.5 |
| 7.1 Vista e descrizione delle parti..... | pag. 5 |
| 8. MONTAGGIO..... | PAG.5 |
| 8.1 Montaggio del letto | pag. 5 |
| 8.2 Montaggio pedaline | pag. 6 |
| 8.3 Collegamento elettrico | pag. 6 |
| 8.4 Montaggio accessorio kit comando a pedale elettrico | pag. 7 |
| 8.5 Montaggio accessorio portarotolo | pag. 8 |
| 9. PRIMA DI OGNI USO..... | PAG.8 |
| 10. AVVERTENZE PER L'UTILIZZO..... | PAG.9 |
| 11. MODALITÀ D'USO..... | PAG.9 |
| 11.1 Modelli a movimentazione elettrica..... | pag. 9 |
| 11.2 Modelli a movimentazione idraulica/pneumatica..... | pag. 9 |
| 12. USO DEL TELECOMANDO (PER MI37XX-MI380X-MI381X-MI390X-MI391X)..... | PAG.9 |
| 12.1 Uso delle ruote | pag. 10 |
| 12.2 Uso del comando a pedale elettrico..... | pag. 10 |
| 13. MANUTENZIONE | PAG.10 |
| 14. PULIZIA E DISINFEZIONE | PAG.10 |
| 14.1 Pulizia..... | pag. 10 |
| 14.2 Disinfezione | pag. 10 |
| 15. CONDIZIONI DI SMALTIMENTO | PAG.11 |
| 15.1 Condizioni di smaltimento generali | pag. 11 |
| 15.2 Avvertenze per il corretto smaltimento del prodotto | pag. 11 |
| ai sensi della direttiva europea 2012/19/UE:..... | pag. 11 |
| 16. DICHIARAZIONE COMPATIBILITÀ ELETTROMAGNETICA..... | PAG.11 |
| 16.1 Guida e dichiarazione del costruttore - Emissioni elettromagnetiche..... | pag. 11 |
| 16.2 Guida e dichiarazione del costruttore - Immunità elettromagnetica..... | pag. 11 |
| 16.3 Distanze di separazione raccomandate tra apparecchi di radiocomunicazione portatili e mobili e il sistema Lytus..... | pag. 14 |
| 17. PARTI DI RICAMBIO E ACCESSORI..... | PAG.14 |
| 18. CARATTERISTICHE TECNICHE | PAG.15 |
| 18.1 Dimensioni e peso MI370X - MI371X | pag. 15 |
| 18.2 Dimensioni e peso MI380X - MI381X | pag. 15 |
| 18.3 Dimensioni e peso MI390X - MI391X..... | pag. 16 |
| 18.4 Dimensioni e peso MI385X - MI386X | pag. 16 |
| 18.5 Dimensioni e peso MI395X - MI396X..... | pag. 17 |
| 18.6 Specifiche tecniche | pag. 18 |
| 19. RISOLUZIONE PROBLEMI | PAG.18 |
| 20. GARANZIA..... | PAG.19 |
| 21. RIPARAZIONI | PAG.19 |
| 21.1 Riparazione in garanzia..... | pag. 19 |
| 21.2 Riparazione di un prodotto non coperto dalla garanzia | pag. 19 |
| 21.3 Prodotti non difettosi | pag. 19 |
| 22. RICAMBI..... | PAG.19 |
| 23. CLAUSOLE ESONERATIVE..... | PAG.20 |

CE Dispositivo medico di classe I

REGOLAMENTO (UE) 2017/745 DEL PARLAMENTO EUROPEO E DEL CONSIGLIO
del 5 aprile 2017 relativo ai dispositivi medici

1. CODICI

- MI370X** Letto da visita medica elettrico larghezza 62 cm (LYTUS)
MI371X Letto da visita medica elettrico larghezza 62 cm con ruote (LYTUS)
MI380X Letto da visita medica elettrico larghezza 68 cm (LYTUS)
MI381X Letto da visita medica elettrico larghezza 68 cm con ruote (LYTUS)
MI385X Letto da visita medica idraulico larghezza 68 cm (LYTUS)
MI386X Letto da visita medica idraulico larghezza 68 cm con ruote (LYTUS)
MI390X Letto da visita medica elettrico larghezza 90 cm (LYTUS)
MI391X Letto da visita medica elettrico larghezza 90 cm con ruote (LYTUS)
MI395X Letto da visita medica idraulico larghezza 90 cm (LYTUS)
MI396X Letto da visita medica idraulico larghezza 90 cm con ruote (LYTUS)

X: Indica il colore del rivestimento

2. INTRODUZIONE

Grazie per aver scelto un letto da visita medica della linea SKEMA by Moretti.

I letti da visita Moretti sono stati progettati e realizzati per soddisfare tutte le vostre esigenze per un utilizzo pratico e sicuro. Questo manuale contiene dei piccoli suggerimenti per un corretto uso del dispositivo da voi scelto e dei preziosi consigli per la vostra sicurezza.

Si consiglia di leggere attentamente la totalità del presente manuale prima di usare il letto da visita medica. In caso di dubbi vi preghiamo di contattare il rivenditore, il quale saprà aiutarvi e consigliarvi correttamente.

3. DESTINAZIONE D'USO

I letti da visita medica professionale Moretti sono destinati al supporto di pazienti durante trattamenti fisioterapici o visite mediche di breve durata.

ATTENZIONE!



- È vietato l'utilizzo del seguente dispositivo per fini diversi da quanto definito nel seguente manuale
- Moretti S.p.A. declina qualsiasi responsabilità su danni derivanti da un uso improprio del dispositivo o da un uso diverso da quanto indicato nel presente manuale
- Il produttore si riserva il diritto di apportare modifiche al dispositivo e al seguente manuale senza preavviso allo scopo di migliorarne le caratteristiche

4. DICHIARAZIONE DI CONFORMITÀ UE

La MORETTI SpA dichiara sotto la sua esclusiva responsabilità che i prodotti fabbricati ed immessi in commercio dalla stessa MORETTI SpA, e facenti parte della famiglia LETTINI DA VISITA PROFESSIONALI - LYTUS sono conformi alle disposizioni applicabili del regolamento 2017/745 sui DISPOSITIVI MEDICI del 5 aprile 2017.

A tal scopo la MORETTI SpA garantisce e dichiara sotto la propria esclusiva responsabilità quanto segue:

1. I dispositivi in oggetto soddisfano i requisiti generali di sicurezza e prestazione così come richiesti dall'allegato I del regolamento 2017/745 come prescritto dall'allegato IV del suddetto regolamento.
2. I dispositivi in oggetto NON SONO STRUMENTI DI MISURA.
3. I dispositivi in oggetto NON SONO DESTINATI AD INDAGINI CLINICHE.
4. I dispositivi in oggetto vengono commercializzati in confezione NON STERILE.
5. I dispositivi in oggetto sono da considerarsi come appartenenti alla classe I in conformità a quanto stabilito dall'allegato VIII del suddetto regolamento.

6. La MORETTI SpA mantiene e mette a disposizione delle Autorità Competenti, per almeno 10 anni dalla data di fabbricazione dell'ultimo lotto, la documentazione tecnica comprovante la conformità al regolamento 2017/745.

Nota: I codici completi di prodotto, il codice di registrazione del Fabbricante (SRN), il codice UDI-DI di base ed eventuali riferimenti a norme utilizzate sono riportati nella Dichiarazione di Conformità UE che MORETTI SPA emette e rende disponibile attraverso i propri canali.

4.1 Norme e direttive di riferimento

Per garantire gli standard di sicurezza per gli utilizzatori ed in assenza di norme specifiche di prodotto, MORETTI SpA verifica i prodotti ispirandosi a test presenti nelle norme:

UNI CEI EN 60601-2-52:2016 Apparecchi elettromedicali. Parte 2-52. Requisiti particolari per la sicurezza di base e le prestazioni essenziali dei letti medici
 UNI EN 12182:2012 Prodotti destinati all'assistenza di persone con disabilità

5. AVVERTENZE GENERALI



Per un utilizzo corretto del dispositivo fare riferimento attentamente al seguente manuale

- Mantenere il prodotto imballato lontano da qualsiasi fonte di calore in quanto l'imballo è fatto di cartone
- La vita utile del dispositivo è determinata dall'usura di parti non riparabili e/o sostituibili e comunque non superiori a 10 anni
- Prestare sempre molta attenzione alla presenza di parti in movimento che potrebbero causare intrappolamenti agli arti e lesioni personali
- Prestare sempre attenzione alla presenza di bambini
- L'utilizzatore e/o il paziente dovrà segnalare qualsiasi incidente grave verificatosi in relazione al dispositivo al fabbricante e all'autorità competente dello Stato membro in cui l'utilizzatore e/o il paziente è stabilito.

6. SIMBOLOGIA UTILIZZATA

| | |
|--|--|
|  | Codice prodotto |
|  | Identificativo univoco del dispositivo |
|  | Marchio CE |
|  | Fabbricante |
|  | Lotto di produzione |
|  | Leggere il manuale per le istruzioni |
|  | Dispositivo Medico |
|  | Condizioni di smaltimento |
|  | Attenzione |
|  | Data di produzione |
|  | Smaltimento prodotto secondo la direttiva CE/19/2012 |

IP54 Protezione da polvere e spruzzi d'acqua

-  Parte applicata di tipo B
-  Classe isolamento II
-  Carico massimo ammesso

7. DESCRIZIONE GENERALE

7.1 Vista e descrizione delle parti

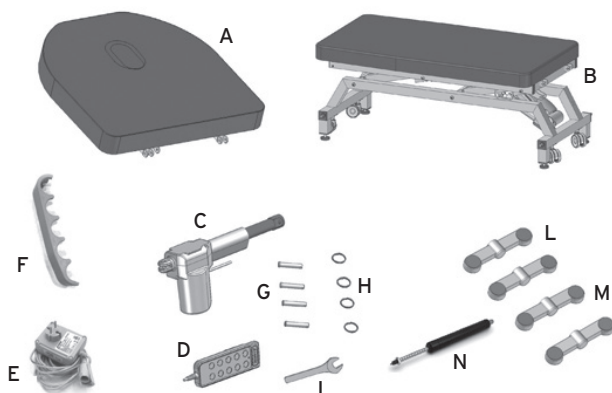

Elenco delle parti

- A. Testata con piano imbottito (solo per MI38X-MI39X)
- B. Telaio con piano imbottito
- C. Attuatore testata (solo per MI380X-MI381X-MI390X-MI391X)
- D. Telecomando (solo per MI37XX-MI380X-MI381X-MI390X-MI391X)
- E. Alimentatore (solo per modelli elettrici MI37XX-MI380X-MI381X-MI390X-MI391X)
- F. Fermo in plastica per connessioni elettriche (solo per modelli elettrici MI37XX-MI380X-MI381X-MI390X-MI391X)
- G. Perni di assemblaggio testata e attuatore (solo per MI38X-MI39X)
- H. Fermi ad anello (solo per MI38X-MI39X)
- I. Chiave a "forchetta" per regolazione dei piedini
- L. Doppio pedale sinistro (solo per MI371X-MI381X-MI386X-MI391X-MI396X)
- M. Doppio pedale destro (solo per MI371X-MI381X-MI386X-MI391X-MI396X)
- N. Attuatore a gas testata (solo per MI385X-MI386X-MI395X-MI396X)

8. MONTAGGIO



ATTENZIONE!

Eeguire queste operazioni con l'ausilio di un altro operatore, prestando molta attenzione per evitare lesioni fisiche e/o danni alle cose durante lo spostamento del letto

8.1 Montaggio del letto

- Aprire il cartone di imballo del letto e verificare che il contenuto corrisponda al modello da voi richiesto e che le parti non abbiano subito danni durante il trasporto. Nel caso contrario contattare immediatamente il vostro rivenditore
- Procedere all'assemblaggio della testata (solo per MI38X-MI39X) e del relativo attuatore al telaio del piano utilizzando i perni del kit accessori (Rif.G) e bloccarli con i fermi di sicurezza ad anello (Rif.H) come in Fig.1

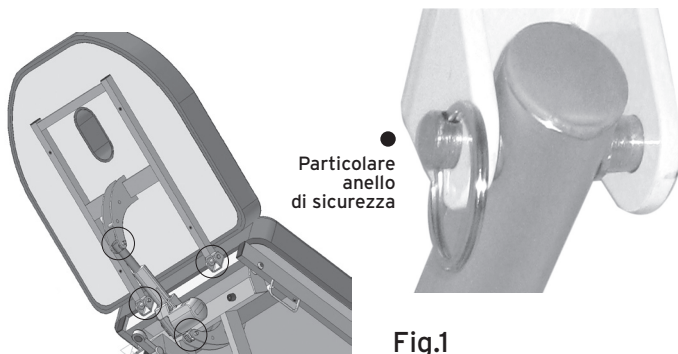

8.2 Montaggio pedaline (solo per MI371X-MI381X-MI386X-MI391X-MI396X)

- Procedere al montaggio delle pedaline di comando delle ruote (Rif.L), rispettando la lettera di riferimento presente sulla pedalina stessa (L= sinistra, R= destra) disponendole come nella Fig.2

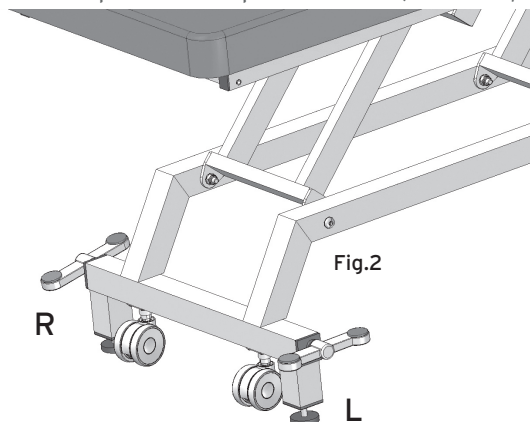

8.3 Collegamento elettrico (solo per MI37XX-MI380X-MI381X-MI390X-MI391X)

- Passare al collegamento elettrico dell'attuatore alzatesta (solo per MI37XX-MI38XX) e del telecomando come illustrato in Fig.3

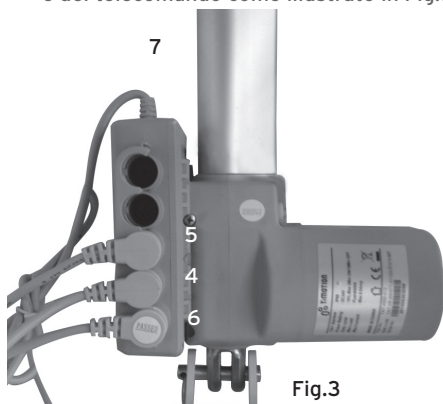

Modello con CENTRALINA TC14

- Rif.4 Attuatore alzatesta
- Rif.5 Attuatore elevazione
- Rif.6 Telecomando
- Rif.7 Cavo collegamento alimentatore

- Bloccare i connettori nella centralina con il fermo in plastica Rif.A in Fig.4

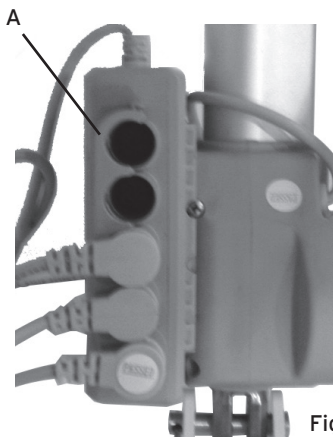
Fig. 4

- Regolazione del piedino

Fig.5

Procedere alla regolazione dei piedini in modo tale che il meccanismo di comando a pedale delle ruote possa lavorare agevolmente. A tal fine regolare l'altezza del piedino in modo tale che la distanza mostrata in figura non superi i 10mm (Fig.5)

IL VOSTRO LETTO È CORRETTAMENTE ASSEMBLATO E PRONTO ALL'USO

8.4 Montaggio accessorio kit comando a pedale elettrico MR320-321 (optional per MI37XX-MI380X-MI381X-MI390X-MI391X)

- Togliere il fermo in plastica che blocca i connettori sulla centralina
- Scollegare il connettore elettrico del telecomando (se già installato) e collegare il connettore elettrico del cavo ad Y presente nel kit
- Inserire nuovamente il fermo in plastica per il bloccaggio dei connettori

Fig.6

- Fissare il cavo ad Y alla gamba del letto predisposta con due fori, con due viti M5 (Fig.6)
- Collegare il connettore del telecomando ad uno dei ingressi sull'adattatore e quello del comando a pedale sull'altro (Fig.7). Sono intercambiabili

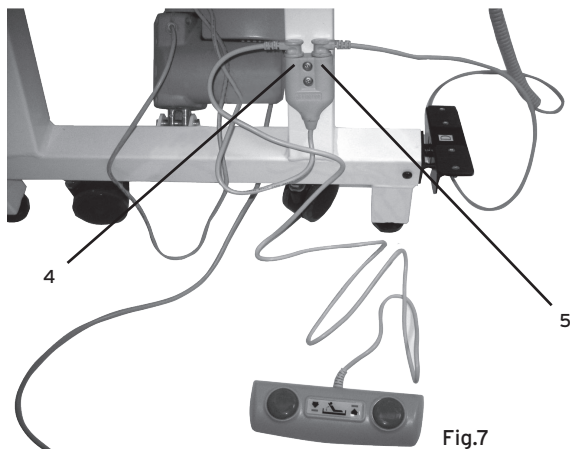

Fig.7

Rif.4 Connettore comando elettrico a pedale

Rif.5 Connettore elettrico telecomando

IL VOSTRO KIT È CORRETTAMENTE ASSEMBLATO E PRONTO ALL'USO

8.5 Montaggio accessorio portarotolo MIA391 (per letto MI370X-MI371X), MIA392 (per letto MI380X-MI381X-MI385X-MI386X) e MIA393/MIA394 (per letto MI390X-MI391X-MI395X-MI396X)

Fissare le due staffe sulla parte terminale del telaio del letto utilizzando 4 viti presenti nel kit. Collegare il tubo portarotolo tramite le due manopole in dotazione, come illustrato in Fig.8

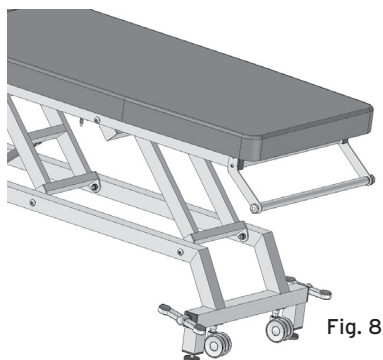

Fig. 8

IL VOSTRO KIT È CORRETTAMENTE ASSEMBLATO E PRONTO ALL'USO

9. PRIMA DI OGNI USO

- Verificare sempre lo stato di usura delle parti meccaniche in gioco in modo tale da garantire un utilizzo del dispositivo in totale sicurezza per persone e cose
- Verificare il corretto assemblaggio del dispositivo con particolare attenzione ai perni e fermi di bloccaggio della testiera, degli attuatori e delle articolazioni meccaniche in generale

10. AVVERTENZE PER L'UTILIZZO

- Prima di effettuare qualsiasi regolazione sul letto assicurarsi che questo sia in posizione stabile sulle gambe
- Prima di effettuare qualsiasi intervento sia di pulizia, di manutenzione o semplicemente di spostamento del letto disconnettere la spina della tensione di rete
- Non utilizzare prese multiple mobili addizionali o cavi di prolunga
- Non collegare al letto alcun dispositivo elettrico non previsti dal funzionamento normale



ATTENZIONE!

Non sedersi con il peso gravante tutto sulla testata in quanto il carico massimo dichiarato per il letto è da intendersi "uniformemente distribuito sulla sua superficie"; in caso contrario si potrebbe danneggiare in modo serio ed irreparabile la struttura del telaio. Moretti Spa declina qualsiasi responsabilità su danni derivanti da un uso improprio e/o diverso da quello riportato in questo manuale d'uso.

11. MODALITÀ D'USO

11.1 Modelli a movimentazione elettrica (MI37XX-MI380X-MI381X-MI390X-MI391X)

Prima di ogni uso collegare il cavo di alimentazione elettrica alla presa di rete 220 vac.

Utilizzare il telecomando in dotazione per regolare l'altezza del letto e l'inclinazione della testata.

11.2 Modelli a movimentazione idraulica/pneumatica (MI39XX)

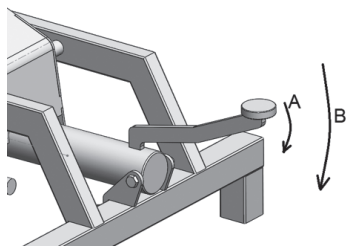

Per attuare il sollevamento del letto, premere a più riprese sul pedale di elevazione come in fig 9 (rif A), per abbassare il letto premere a fondo il pedale di elevazione (rif B).

Per riposizionare la testata, premere la leva di sblocco dell'attuatore pneumatico che si trova sotto la testata stessa.

12. USO DEL TELECOMANDO (PER MI37XX-MI380X-MI381X-MI390X-MI391X)

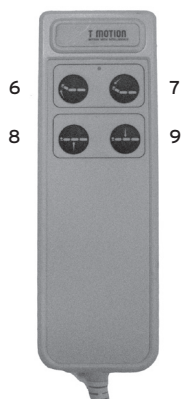

- | | |
|-------|---|
| Rif.6 | Pulsante regolazione alza-testa "SU" (solo MI380X-MI381X-MI390X-MI391X) |
| Rif.7 | Pulsante regolazione alza-testa "GIÙ" (solo MI380X-MI381X-MI390X-MI391X) |
| Rif.8 | Pulsante regolazione elevazione letto "SU" |
| Rif.9 | Pulsante regolazione elevazione letto "GIÙ" |

N.B. Sul telecomando è presente un Led luminoso di colore giallo che si accende indicando lo stato di azionamento di uno dei pulsanti

12.1 Uso delle ruote (solo modelli MI371X-MI381X-MI386X-MI391X-MI396X)



Attenzione!

- Prima di spostare il letto ricordarsi sempre di scollegare il cavo di alimentazione elettrica dalla presa di corrente
- Non spostare il letto con pazienti a bordo

Questi modelli di letti sono dotati di 4 ruote piroettanti per agevolare lo spostamento. Il sistema di ruote è stato studiato per garantire un facile e veloce intervento attraverso un comando a pedale. Quando si desidera spostare il letto è sufficiente premere con un piede le due pedaline presenti sullo stesso lato del letto (destra o sinistra) in modo tale che il letto si sollevi dai piedini di appoggio. Spostare comodamente il letto nella posizione desiderata, quindi premere nuovamente le pedaline per abbassare le ruote e riposizionare il letto sui piedini in modo da renderlo stabile

12.2 Uso del comando a pedale elettrico MR320-MR321 (optional)



10



11

Rif.10 **MR320** Comando a pedale elettrico per attivare l'alza-testa

Rif.11 **MR319 (per MI37XX) / MR321** Comando a pedale elettrico per attivare l'elevazione del piano letto

I due modelli di pedaline elettriche differiscono solo nella funzione che vanno ad attivare

1. Per sollevare premere con il piede la freccia in alto (della testata oppure del piano letto)
2. Per abbassare premere con il piede la freccia in basso (della testata oppure del piano letto)

N.B. Per il montaggio del comando a pedale elettrico (MR320 oppure MR321) fare riferimento al paragrafo "MONTAGGIO" di questo manuale istruzioni

13. MANUTENZIONE

I dispositivi della linea SKEMA by Moretti al momento dell'immissione in commercio sono controllati accuratamente e provvisti di marchio CE

Per la sicurezza del paziente e del medico si raccomanda di far controllare, almeno una volta l'anno, l'idoneità all'uso del vostro prodotto

Per ispezione periodica si intende un esame delle seguenti parti:

- La struttura portante del letto e del meccanismo di sollevamento con i relativi attacchi, comandi, dispositivi di sicurezza
- Controllare montaggio e funzionamento del meccanismo di comando ruote
- Verificare l'integrità dei cavi e delle spine di rete
- Verificare tutti i punti di saldatura

In caso di riparazione devono essere utilizzati soltanto ricambi ed accessori originali

14. PULIZIA E DISINFEZIONE

14.1 Pulizia

Utilizzare esclusivamente un panno umido e del sapone neutro.

Successivamente asciugare bene prima dell'utilizzo

Utilizzare acqua ad una temperatura non superiore ai 30 °C.

Non utilizzare macchine di lavaggio a getto di acqua e/o vapore

14.2 Disinfezione

Se necessario effettuare una disinfezione del prodotto utilizzando un comune detergente disinfettante.

N.B. Evitare assolutamente di utilizzare prodotti acidi, alcalini o solventi come ad esempio l'acetone o il diluente

15. CONDIZIONI DI SMALTIMENTO

15.1 Condizioni di smaltimento generali

In caso di smaltimento del dispositivo non usare mai i normali sistemi di conferimento dei rifiuti solidi urbani. Si raccomanda invece di smaltire il dispositivo attraverso le comuni isole ecologiche comunali per le previste operazioni di riciclo dei materiali utilizzati

15.2 Avvertenze per il corretto smaltimento del prodotto

ai sensi della direttiva europea 2012/19/UE:

Alla fine della sua vita utile il prodotto non deve essere smaltito insieme ai rifiuti urbani. Può essere consegnato presso gli appositi centri di raccolta differenziata predisposti dalle amministrazioni comunali, oppure presso i rivenditori che forniscono questo servizio. Smaltire separatamente il prodotto consente di evitare possibili conseguenze negative per l'ambiente e per la salute derivanti da un suo smaltimento inadeguato e permette di recuperare i materiali di cui è composto al fine di ottenere un importante risparmio di energie e di risorse. Per rimarcare l'obbligo di smaltire separatamente le apparecchiature elettromedicali, sul prodotto è riportato il marchio del contenitore di spazzatura mobile sbarrato

16. DICHIARAZIONE COMPATIBILITÀ ELETTROMAGNETICA

16.1 Guida e dichiarazione del costruttore - Emissioni elettromagnetiche

Il sistema Lytus è previsto per funzionare nell'ambiente elettromagnetico sotto specificato. Il cliente o l'utilizzatore del sistema Lytus deve garantire che esso viene usato in tale ambiente.

| PROVA DI EMISSIONE | CONFORMITÀ | AMBIENTE ELETTROMAGNETICO - GUIDA |
|---|------------|---|
| Emissioni RF CISPR 11 | Gruppo 1 | Il sistema Lytus è adatto a tutti i locali compresi quelli domestici e quelli collegati direttamente ad un'alimentazione di rete pubblica a bassa tensione che alimenta edifici usati per scopi domestici |
| Emissioni RF CISPR 11 | Classe B | |
| Emissioni armoniche IEC 61000-3-2 | Classe A | |
| Emissioni di fluttuazione di tensione/flicker IEC 61000-3-3 | Conforme | |

△ Attenzione:

1. Il dispositivo non deve essere utilizzato adiacente o accatastato con altre apparecchiature. Se è necessaria l'uso adiacente o impilato, è necessario osservare il dispositivo per verificare il funzionamento normale nella configurazione in cui verrà utilizzato.
2. Utilizzare accessori, trasduttori e cavi diversi da quelli specificati o forniti dal produttore di questa apparecchiatura potrebbero causare maggiori emissioni elettromagnetiche o diminuzione dell'immunità elettromagnetica di questa apparecchiatura e provocare un funzionamento improprio.
3. L'apparecchiatura di comunicazione RF portatile (incluse le periferiche come i cavi dell'antenna e le antenne esterne) deve essere utilizzata non più vicina a 30 cm (12 pollici) da qualsiasi parte della pompa, compresi i cavi specificati dal produttore. In caso contrario, potrebbe verificarsi un degrado delle prestazioni di questa apparecchiatura.

16.2 Guida e dichiarazione del costruttore - Immunità elettromagnetica

Il sistema Lytus è previsto per funzionare nell'ambiente elettromagnetico sotto specificato. Il cliente o l'utilizzatore del sistema Lytus deve garantire che esso viene usato in tale ambiente.

| Norme EMC | Livello di prova | | Livello di conformità | Electromagnetic Environment-Guidance |
|--|--|--|--|--|
| | Ambiente per cure sanitarie professionali | Ambiente per cure sanitarie domestiche | | |
| Scarica elettrostatica (ESD) IEC 61000-4-2 | +8kV contatto +15kV aria | | +8kV contatto +15kV aria | I pavimenti devono essere in legno,calcestruzzo o in ceramica. Se I pavimenti sono ricoperti di materiale sintetico, l'umidità relativa dovrebbe essere al minimo 30% |
| Transitori/treni elettrici veloci IEC61000-4-4 | + 2kV per le linee di alimentazione di potenza + 1kV per linea di ingresso/uscita | | + 2kV per le linee di alimentazione di potenza + 1kV per linea di ingresso/uscita | La qualità della tensione di rete dovrebbe essere quella di un tipico ambiente commerciale o ospedaliero |
| Sovratensione IEC61000-4-5 | + 1 kV linea a linea + 2 kV linea a terra | + 1 kV linea a linea | + 1 kV linea a linea | L'alimentazione elettrica di rete dovrebbe essere di un tipico ambiente commerciale o ospedaliero |
| Buchi di tensione, brevi interruzioni e variazioni di tensione sulle linee di ingresso dell'alimentazione IEC61000-4-11 | Cali di tensione: i) riduzione del 100% per 0,5 periodo, ii) riduzione del 100% per 1 periodo, iii) riduzione del 30% per i periodi di 25/30, Interruzioni di tensione: Riduzione del 100% per periodo di 250/300 | | 230V | La qualità della tensione di rete dovrebbe essere quella di un tipico ambiente commerciale o ospedaliero. Se l'utilizzatore del sistema Lytus richiede un funzionamento continuato anche durante l'interruzione della tensione di rete, si raccomanda di alimentare il sistema Lytus con un gruppo di continuità (UPS) o con batterie. |
| Campo magnetico a frequenza di rete (50/60Hz) IEC61000-4-8 | 30 A/m | 30 A/m | 30 A/m | I campi magnetici a frequenzadi rete dovrebbero avere livelli caratteristici di una località tipica in ambiente commerciale o ospedaliero |

| Norme EMC | Livello di prova | | Livello di conformità | Electromagnetic Environment-Guidance |
|--|---|---|-----------------------|---|
| | Ambiente per cure sanitarie professionali | Ambiente per cure sanitarie domestiche | | |
| RF condotta IEC 61000-4-6 | 3 Vrms 0,15 MHz - 80 MHz 6 Vrms nelle bande ISM tra 0,15 MHz e 80 MHz 80 % AM at 1 kHz | 3 Vrms 0,15 MHz - 80 MHz 6 Vrms nelle bande ISM in quelle radiofoniche amatoriali 0,15 MHz and 80 MHz 80 % AM at 1 kHz | 6Vrms | Il sistema Lytus deve essere usato solo in luoghi schermati con un minimo di efficienza schermante RF e, per ciascun cavo che entra nel locale schermato, con un minimo di attenuazione dei filtri RF Distanza di separazione raccomandata $d = \sqrt{P} 150 \text{ kHz a } 80 \text{ MHz}$ $d = 0.6\sqrt{P} 80\text{MHz}$ a 800 MHz $d = 1.2\sqrt{P} 800 \text{ MHz}$ a 2.7G MHz Dove P è il massimo indice di uscita del tra- smettitore in watts (W) secondo il produttore del trasmettitore e "d" è la distanza di separazione raccomandata in metri (m). Le resistenze dei campi dal trasmettitore fisso RF, come determinato da un luogo del rilevamento, (a) devono essere inferiori al livello di conformità di ogni gamma di frequenza. (b) Possono verificarsi interferenze in prossimità di apparecchi contrassegnati dal seguente simbolo:  |
| RF irradiata campo EM IEC61000-4-3 | 3 V/m 80 MHz to 2.7 GHz 80 % AM at 1 kHz 385-6000 MHz, 9-28V/m, 80% AM(1kHz) modalità ad impulsi e altre modulazioni | 10 V/m 80 MHz to 2,7 GHz 80 % AM at 1 kHz 385-6000 MHz, 9-28V/m, 80% AM(1kHz) modalità ad impulsi e altre modulazioni | 10V/m | |

NOTA 1: UT è la tensione di rete in c.a. prima dell'applicazione del livello di prova

NOTA 2: A 80MHz e 800MHz viene applicata la massima gamma di frequenza

NOTA 3: Queste linee guida potrebbero non applicarsi in tutte le situazioni. La propagazione elettromagnetica è influenzata dall'assorbimento e dalla riflessione di strutture, oggetti e persone

a) Le intensità di campo per trasmettitori fissi come le stazioni base per radiotelefoni (cellulari e cordless) e radiomobili terrestri, apparecchi di radioamatori, trasmettitori radio in AM e FM e trasmettitori TV non possono essere previste teoreticamente e con precisione. Per valutare un ambiente elettromagnetico causato da trasmettitori RF fissi, si dovrebbe considerare un'indagine elettromagnetica del sito. Se l'intensità di campo misurata al di fuori del locale schermato, nel luogo in cui si usa un sistema Lytus, supera il livello di conformità applicabile di cui sopra, si dovrebbe porre sotto osservazione il funzionamento normale del sistema Lytus. Se si notano prestazioni anormali, possono essere necessarie misure aggiuntive come una diversa collocazione del sistema Lytus o l'uso di un locale schermato con una maggior efficienza schermante RF e maggior attenuazione dei filtri

b) Oltre la gamma di frequenza di 150KHz fino a 80MHz, il campo di resistenza dovrebbe essere inferiore a 10 V/m.

16.3 Distanze di separazione raccomandate tra apparecchi di radiocomunicazione portatili e mobili e il sistema Lytus

Il sistema Lytus è previsto per funzionare in un ambiente elettromagnetico in cui sono sotto controllo i disturbi irradiati RF. Il cliente o l'operatore del sistema Lytus possono contribuire a prevenire interferenze elettromagnetiche assicurando una distanza minima fra gli apparecchi di comunicazione mobili e portatili a RF (trasmettitori) e il sistema Lytus come sotto raccomandato, in relazione alla potenza di uscita massima degli apparecchi di radiocomunicazione.

| Potenza di uscita massima del trasmettitore specificata W | Distanza di separazione alla frequenza del trasmettitore (m) | | |
|---|--|--|--|
| | Da 150 KHz fino a 80MHz $d=\sqrt{P}$ | Da 80MHz fino a 800MHz $d=0,6\sqrt{P}$ | Da 800MHz fino a 2.7 GHz $d=1,2\sqrt{P}$ |
| 0.01 | 0.1 | 0.06 | 0.12 |
| 0.1 | 0.31 | 0.19 | 0.38 |
| 1 | 1 | 0.6 | 1.2 |
| 10 | 3.1 | 1.9 | 3.8 |
| 100 | 10 | 6 | 12 |

Per i trasmettitori specificati per una potenza massima di uscita non riportata sopra, la distanza di separazione raccomandata "d" in metri (m) può essere calcolata usando l'equazione applicabile alla frequenza del trasmettitore, ove "P" è la potenza massima nominale d'uscita del trasmettitore in Watt (W) secondo il costruttore del trasmettitore.

NOTA 1 A 80MHz e 800MHz si applica l'intervallo di frequenza più alto

NOTA 2: Queste linee guida potrebbero non applicarsi in tutte le situazioni. La propagazione elettromagnetica è influenzata dall'assorbimento e dalla riflessione di strutture, oggetti e persone





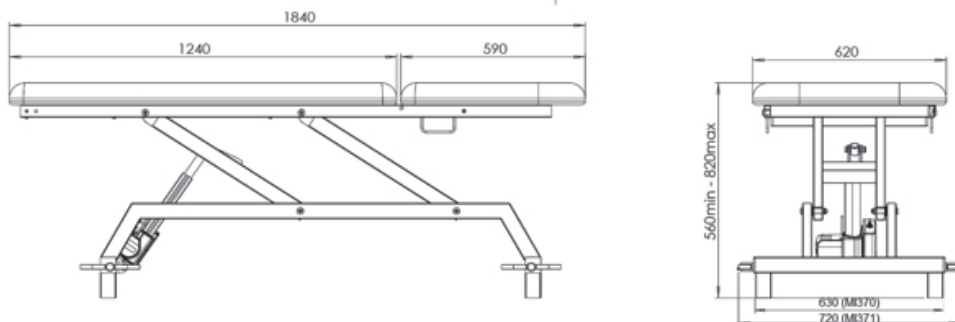

17. PARTI DI RICAMBIO E ACCESSORI

Per le parti di ricambio e gli accessori fare riferimento esclusivamente al catalogo generale Moretti

- MR319** Comando a pedale elettrico per regolazione elevazione piano letto per MI37XX
- MR320** Comando a pedale elettrico per regolazione alza-testa per MI380X-MI381X-MI390X-MI391X
- MR321** Comando a pedale elettrico per regolazione elevazione piano letto per MI380X-MI381X-MI390X-MI391X
- MIA391** Supporto portarotolo da 60cm per MI37XX
- MIA392** Supporto portarotolo da 60cm per MI380X-MI381X-MI385X-MI386X
- MIA393** Supporto portarotolo da 60cm per MI390X-MI391X-MI395X-MI396X
- MIA394** Supporto portarotolo da 80cm per MI390X-MI391X-MI395X-MI396X





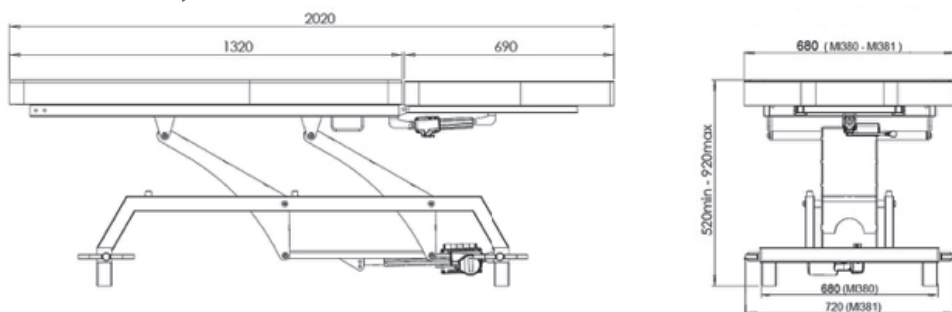

18. CARATTERISTICHE TECNICHE
18.1 Dimensioni e peso MI370X - MI371X

| | |
|-----------------------------|-------------|
| Dimensioni esterne (MI370): | mm 1840x630 |
| Dimensioni esterne (MI371): | mm 1840x720 |
| Altezza min. | mm 560 |
| Altezza max. | mm 820 |
| Angolo massimo alza-testa: | 60° |

| | | | |
|--|--|---|---|
|  Dim. imballo MI370-MI371 |  L: 1850 mm |  P: 730 mm |  H: 570 mm |
|  Peso imballo MI370-MI371 | 54 kg | | |
|  Peso letto MI370-MI371 | 48 kg | | |
|  Portata massima | 150 kg | | |

18.2 Dimensioni e peso MI380X - MI381X







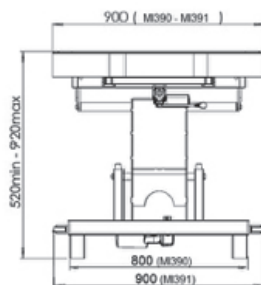
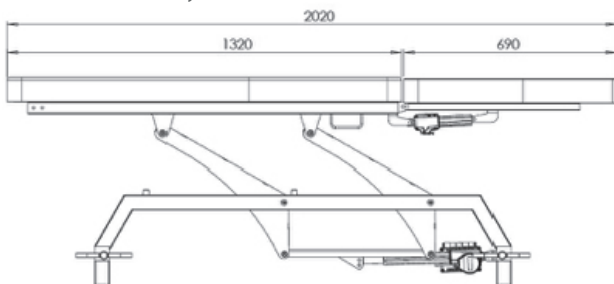

| | |
|------------------------------|-------------|
| Dimensioni esterne (MI380X): | mm 2020x680 |
| Dimensioni esterne (MI381X): | mm 2020x720 |
| Altezza min. | mm 520 |
| Altezza max. | mm 920 |
| Angolo massimo alza-testa: | 60° |

| | | | |
|--|--|---|---|
|  Dim. imballo MI380-MI381 |  L: 1785 mm |  P: 730 mm |  H: 535 mm |
|  Peso imballo MI380-MI381 | 68 kg | | |
|  Peso letto MI380-MI381 | 60 kg | | |
|  Portata massima | 200 kg | | |

18.3 Dimensioni e peso MI390X - MI391X







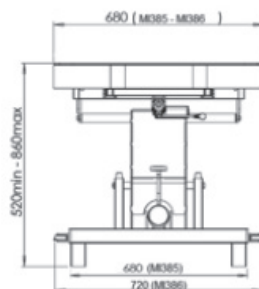
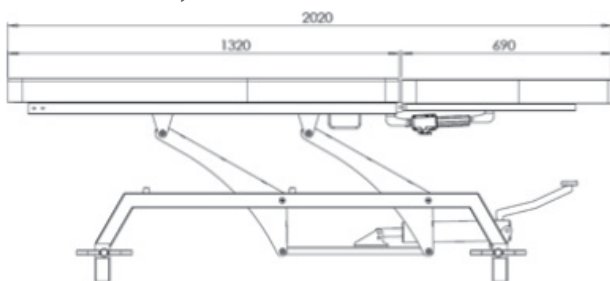

| | |
|------------------------------|-------------|
| Dimensioni esterne (MI390X): | mm 2020x800 |
| Dimensioni esterne (MI391X): | mm 2020x900 |
| Altezza min. | mm 520 |
| Altezza max. | mm 920 |
| Angolo massimo alza-testa: | 60° |

| | | | |
|---|--|---|---|
|  Dim. imballo MI390-MI391 |  L: 2040 mm |  P: 940 mm |  H: 535 mm |
|  Peso imballo MI390-MI391 | 86 kg | | |
|  Peso letto MI390-MI391 | 75 kg | | |
|  Portata massima | 200 kg | | |

18.4 Dimensioni e peso MI385X - MI386X







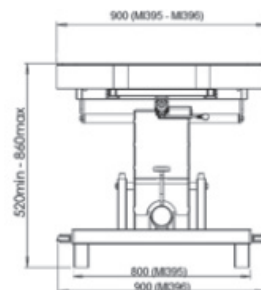
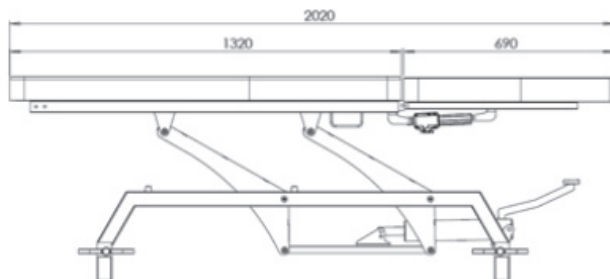

| | |
|------------------------------|-------------|
| Dimensioni esterne (MI385X): | mm 2020x680 |
| Dimensioni esterne (MI386X): | mm 2020x720 |
| Altezza min. | mm 520 |
| Altezza max. | mm 860 |
| Angolo massimo alza-testa: | 60° |

| | | | |
|--|--|---|---|
|  Dim. imballo MI385-MI386 |  L: 2040 mm |  P: 730 mm |  H: 535 mm |
|  Peso imballo MI385-MI386 | 69 kg | | |
|  Peso letto MI385-MI386 | 61 kg | | |
|  Portata massima | 180 kg | | |

18.5 Dimensioni e peso MI395X - MI396X



| | |
|------------------------------|-------------|
| Dimensioni esterne (MI395X): | mm 2020x900 |
| Dimensioni esterne (MI396X): | mm 2020x900 |
| Altezza min. | mm 520 |
| Altezza max. | mm 860 |
| Angolo massimo alza-testa: | 60° |

| | | | |
|--|--|---|---|
|  Dim. imballo MI395-MI396 |  L: 2040 mm |  P: 940 mm |  H: 535 mm |
|  Peso imballo MI395-MI396 | 89 kg | | |
|  Peso letto MI395-MI396 | 78 kg | | |
|  Portata massima | 180 kg | | |

18.6 Specifiche tecniche

| | |
|---|--|
| Forza richiesta per azionare i comandi sul telecomando (MI37XX-MI380-MI381-MI390-MI391) | 5 N |
| Forza richiesta per azionare il pedale (MI385-MI386-MI395-MI396) | 30N |
| Alimentazione elettrica | 220-240V AC 50Hz, 600 mA |
| Tensione in uscita dalla centralina | 24 VDC |
| Classe di protezione | IP 54 |
| Livello di rumorosità | < 45 DB |
| Classe di isolamento | Classe 2 |
| Materiali utilizzati | Struttura in tubolare d'acciaio verniciato a polveri, piano in gommapiuma rivestita di PVC |

19. RISOLUZIONE PROBLEMI

| SINTOMI | PROBABILI CAUSE | SOLUZIONE |
|---|--|---|
| Nessun comando funzionante | <ol style="list-style-type: none"> 1. La spina elettrica non è collegata alla presa tensione di rete 2. Il telecomando non è collegato alla centralina 3. Probabile difetto al telecomando o centralina | <ol style="list-style-type: none"> 1. Collegare la spina elettrica 2. Controllare ed eventualmente collegare il telecomando alla centralina 3. Contattare il centro assistenza per una diagnosi più precisa del problema |
| L'alza-testa elettrico non funziona | <ol style="list-style-type: none"> 1. L'attuatore alza-testa non è collegato alla centralina 2. L'attuatore o telecomando o centralina possono essere difettosi | <ol style="list-style-type: none"> 1. Controllare ed eventualmente collegare l'attuatore alla centralina 2. Contattare il centro assistenza per una diagnosi più precisa del problema |
| L'elevazione elettrica del piano non funziona | <ol style="list-style-type: none"> 1. L'attuatore elevazione non è collegato alla centralina 2. L'attuatore o telecomando o centralina possono essere difettosi | <ol style="list-style-type: none"> 1. Controllare ed eventualmente collegare l'attuatore alla centralina 2. Contattare il centro assistenza per una diagnosi più precisa del problema |
| Il comando a pedale non funziona | <ol style="list-style-type: none"> 1. Il comando a pedale non è collegato al cavo Y 2. Il cavo Y non è collegato alla centralina 3. La centralina elettronica e/o gli attuatori potrebbero essere difettosi | <ol style="list-style-type: none"> 1. Controllare ed eventualmente collegare il comando a pedale al cavo Y 2. Collegare il cavo a Y alla centralina 3. Contattare il centro assistenza per una diagnosi più precisa del problema |

20. GARANZIA

Tutti i prodotti Moretti sono garantiti da difetti di materiale o fabbricazione per un periodo di 2 (due) anni dalla data di vendita del prodotto, salvo eventuali esclusioni e limitazioni specificate di seguito. Questa garanzia non è valida in caso di uso improprio, abuso o modifica del prodotto e per la mancata aderenza alle istruzioni per l'uso. La corretta destinazione d'uso del prodotto è indicata nel manuale d'uso

Moretti non è responsabile di danni risultanti, di lesioni personali o quant'altro causato o relativo all'installazione e/o all'uso dell'apparecchiatura non scrupolosamente conforme alle istruzioni riportate nei manuali per l'installazione, il montaggio e l'uso

Moretti non garantisce i prodotti Moretti contro danni o difetti nelle seguenti condizioni: calamità naturali, operazioni di manutenzione o riparazione non autorizzate, danni derivanti da problemi dell'alimentazione elettrica (dove prevista), utilizzo di parti o componenti non forniti da Moretti, mancata aderenza alle linee guida e istruzioni per l'uso, modifiche non autorizzate, danni di spedizione (diversa dalla spedizione originale da Moretti), oppure dalla mancata esecuzione della manutenzione così come indicato nel manuale

Non sono coperti da questa garanzia componenti usurabili se il danno è da imputarsi al normale utilizzo del prodotto.

21. RIPARAZIONI

21.1 Riparazione in garanzia

Nel caso in cui un prodotto Moretti presenti difetti di materiale o fabbricazione durante il periodo di garanzia, Moretti valuterà con il cliente se il difetto del prodotto è coperto dalla garanzia. Moretti, a sua insindacabile discrezione, può sostituire o riparare l'articolo in garanzia, presso un rivenditore Moretti specificato o presso la propria sede. I costi della manodopera relativi alla riparazione del prodotto possono essere a carico di Moretti se si determina che la riparazione ricade nell'ambito della garanzia. Una riparazione o sostituzione non rinnova né proroga la garanzia

21.2 Riparazione di un prodotto non coperto dalla garanzia

Si può restituire, affinché sia riparato, un prodotto non coperto dalla garanzia solo dopo aver ricevuto autorizzazione preventiva dal servizio clienti Moretti. I costi della manodopera e di spedizione relativi a una riparazione non coperta dalla garanzia saranno completamente a carico del cliente o del rivenditore. Le riparazioni su prodotti non coperti dalla garanzia sono garantite per 6 (sei) mesi, a decorrere dal giorno in cui si riceve il prodotto riparato

21.3 Prodotti non difettosi

Il cliente sarà avvisato se, dopo avere esaminato e provato un prodotto restituito, Moretti conclude che il prodotto non è difettoso. Il prodotto sarà restituito al cliente e saranno a suo carico i costi di spedizione dovuti alla restituzione

22. RICAMBI

I ricambi originali Moretti sono garantiti per 6 (sei) mesi a decorrere dal giorno in cui si riceve il ricambio

23. CLAUSOLE ESONERATIVE

Salvo quanto specificato espressamente in questa garanzia ed entro i limiti di legge, Moretti non offre nessun'altra dichiarazione, garanzia o condizione, espressa o implicita, comprese eventuali dichiarazioni, garanzie o condizioni di commerciabilità, idoneità per uno scopo particolare, non violazione e non interferenza. Moretti non garantisce che l'uso del prodotto Moretti sarà ininterrotto o senza errori. La durata di eventuali garanzie implicite che possano essere imposte dalle norme di legge è limitata al periodo di garanzia, nei limiti delle norme di legge. Alcuni stati o paesi non permettono limitazioni sulla durata di una garanzia implicita oppure l'esclusione o la limitazione di danni accidentali o indiretti in relazione a prodotti per i consumatori. In tali stati o paesi, alcune esclusioni o limitazioni di questa garanzia possono non applicarsi all'utente. La presente garanzia è soggetta a variazioni senza preavviso



CERTIFICATO DI GARANZIA

Prodotto _____

Acquistato in data _____

Rivenditore _____

Via _____ **Località** _____

Venduto a _____

Via _____ **Località** _____



Via Bruxelles, 3 - Melegnano 52022 Cavriglia (Arezzo) Tel. +39 055 96 21 11

www.morettispa.com email: info@morettispa.com

MADE IN ITALY

MORETTI S.P.A.

Via Bruxelles, 3 - Meleto
52022 Cavriglia (Arezzo)

Tel. +39 055 96 21 11
Fax. +39 055 96 21 200

www.morettispa.com
info@morettispa.com

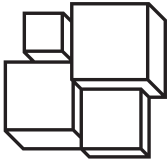

SKEMA[®]FORM

MA M137XX - M138XX - M139XX 02 A _ ENG_09-2020

EXAMINATION COUCH

INSTRUCTIONS MANUAL



INDEX

| | |
|---|---------------|
| 1. CODES | PAG.3 |
| 2. INTRODUCTION | PAG.3 |
| 3. INTENDED USE | PAG.3 |
| 4. DECLARATION OF CONFORMITY | PAG.3 |
| 4.1 Applicable regulations and directives..... | pag. 4 |
| 5. GENERAL WARNINGS | PAG.4 |
| 6. SYMBOLS | PAG.4 |
| 7. GENERAL DESCRIPTION | PAG.5 |
| 7.1 Parts view..... | pag. 5 |
| 8. ASSEMBLING | PAG.5 |
| 8.1 Bed assembling..... | pag. 5 |
| 8.2 Pedal assembling..... | pag. 6 |
| 8.3 Actuator connection..... | pag. 6 |
| 8.4 Electric assembling the footswitc..... | pag. 7 |
| 8.5 Paper roll holder..... | pag. 8 |
| 9. BEFORE USE | PAG.9 |
| 10. WARNINGS FOR A CORRECT USE | PAG.9 |
| 11. HOW TO USE | PAG.9 |
| 11.1 Electric model..... | pag. 9 |
| 11.2 Hydraulic/gas spring model..... | pag. 9 |
| 12. USE THE REMOTE CONTROL (ONLY FOR MI37X-MI380X-MI381X-MI390X-MI391X) | PAG.10 |
| 12.1 Castors use..... | pag. 10 |
| 12.2 Electrical footswitch..... | pag. 10 |
| 13. MAINTENANCE | PAG.11 |
| 14. CLEANING AND DISINFECTION | PAG.11 |
| 14.1 Cleaning..... | pag. 11 |
| 14.2 Disinfection..... | pag. 11 |
| 15. CONDITIONS OF DISPOSAL | PAG.11 |
| 15.1 General conditions of disposal..... | pag. 11 |
| 15.2 Correct treatment of electrical parts (Directive 2012/19/UE)..... | pag. 11 |
| 16. DECLARATION OF ELECTROMAGNETIC COMPATIBILITY | PAG.12 |
| 16.1 Guidance and Manufacturer's Declaration - Electromagnetic Emissions..... | pag. 12 |
| 16.2 Guidance and Manufacturer's Declaration - Electromagnetic Immunity..... | pag. 13 |
| 16.3 Recommended separation distances between portable and mobile RF communications equipment and this device..... | pag. 15 |
| 17. SPARE PARTS AND ACCESSORIES | PAG.15 |
| 18. TECHNICAL FEATURES | PAG.16 |
| 18.1 Dimension and weight MI370X-MI371X..... | pag. 16 |
| 18.2 Dimension and weight MI380X - MI381X..... | pag. 16 |
| 18.3 Dimension and weight MI390X - MI391X..... | pag. 17 |
| 18.4 Dimension and weight MI385X - MI386X..... | pag. 17 |
| 18.5 Dimension and weight MI395X - MI396X..... | pag. 18 |
| 18.6 Technical specifications..... | pag. 19 |
| 19. TROUBLE SHOOTING | PAG.19 |
| 20. WARRANTY | PAG.20 |
| 21. REPAIRING | PAG.20 |
| 21.1 Warranty repair..... | pag. 20 |
| 21.2 Repair not covered by warranty..... | pag. 20 |
| 21.3 Non-defective devices..... | pag. 20 |
| 22. SPARE PARTS | PAG.20 |
| 23. EXEMPT CLAUSES | PAG.20 |



REGULATION (EU) 2017/745 OF THE EUROPEAN PARLIAMENT AND OF THE COUNCIL
of 5 April 2017 concerning medical devices

1. CODES

- MI370X** LYTUS Electric examination couch, 62 cm
- MI371X** LYTUS Electric examination couch, 62 cm, with castors
- MI380X** LYTUS Electric examination couch 68 cm
- MI381X** LYTUS Electric examination couch, 68 cm, with castors
- MI385X** LYTUS Hydraulic examination couch, 68 cm
- MI386X** LYTUS Hydraulic examination couch, 68 cm, with castors
- MI390X** LYTUS Electric examination couch, 90 cm
- MI391X** LYTUS Electric examination couch, 90 cm, with castors
- MI395X** LYTUS Hydraulic examination couch, 90 cm
- MI396X** LYTUS Hydraulic examination couch, 90 cm, with castors

X: Different pad colors

2. INTRODUCTION

Thank you for purchasing a SKEMA examination couch by Moretti S.p.A.

The se products are designed and manufactured to meet all your needs for a practical, correct and safe use. This manual contains small suggestions for proper use of the device you have chosen and valuable advice for your security. You may read the complete manual before using the product, in case of doubts please contact your dealer, who will help and advise you properly.

3. INTENDED USE

Moretti examination beds are intended for patient diagnosis, treatment and monitoring.

WARNING!



- Do not use the product for a purpose not indicated in this manual
- Moretti S.p.A declines all responsibilities for any consequences resulting from an incorrect use of this product and from unauthorized alteration to the frame of the product
- The manufacturer reserves the right to change the information contained in this document without previous notice

4. DECLARATION OF CONFORMITY

Moretti S.p.A. declares under its sole responsibility that the product made and traded by Moretti S.p.A. and belonging to the group of PROFESSIONAL EXAMINATION COUCHES - LYTUS complies with the provisions of the regulation 2017/745 on MEDICAL DEVICES of 5 April 2017.

For this purpose, Moretti S.p.A. guarantees and declares under its sole responsibility what follows:

1. The devices satisfy the requirements of general safety and performance requested by the Annex I of regulation 2017/745 as laid down by the Annex IV of the above mentioned regulation.
2. The devices ARE NOT MEASURING INSTRUMENTS.
3. The devices ARE NOT MADE FOR CLINICAL TESTS.
4. The devices are packed in NON-STERILE BOX.
5. The devices belong to class I in accordance with the provisions of Annex VIII of the above mentioned regulation
6. Moretti S.p.A. provides to the Competent Authorities the technical documentation to prove the conformity to the 2017/745 regulation, for at least 10 years from the last lot production.

Note: Complete product codes, the manufacturer registration code (SRN), the UDI-DI code and any references to used regulations are included in the EU declaration of conformity that Moretti S.p.A. releases and makes available through its channels.

4.1 Applicable regulations and directives

In order to satisfy safety standards for users, Moretti S.p.A. complies with the following standards:











| | |
|----------------------------|---|
| UNI CEI EN 60601-2-52:2016 | Electro-medical equipment. Part 2-52. Special requirements for the basic safety and essential performance of medical beds |
| UNI EN 12182:2012 | Products intended for the assistance of people with disabilities |

5. GENERAL WARNINGS

For a correct use of the product, please refer to the present manual

- Keep the packed examination bed away from heat sources
- **SERVICE LIFE-** the examination bed service life is determined by wear of parts not repairable and/or replaceable and in any case not exceed 10 years
- **ALWAYS** pay close attention to the presence of moving parts that could cause entrapment limbs and injuries
- **DO NOT** allow children to play on or operate the bed
- The user and/or the patient will have to report any serious accident that have occurred related the device to the manufacturer and appropriate authority of the State which the user and/or patient belongs to.

6. SYMBOLS

| | |
|--|--|
|  | Product code |
|  | Unique Device Identification |
|  | CE mark |
|  | Manufacturer |
|  | Batch Lot |
|  | Read the instruction manual |
|  | Medical Device |
|  | Conditions of disposal |
|  | Attention, should read the instructions |
|  | Production dates |
|  | Waste Electrical & Electronic Equipment (WEEE) |

IP54 Protection against dust and water splashes

 B Type



Double insulation class



Maximum permissible load

7. GENERAL DESCRIPTION

7.1 Parts view

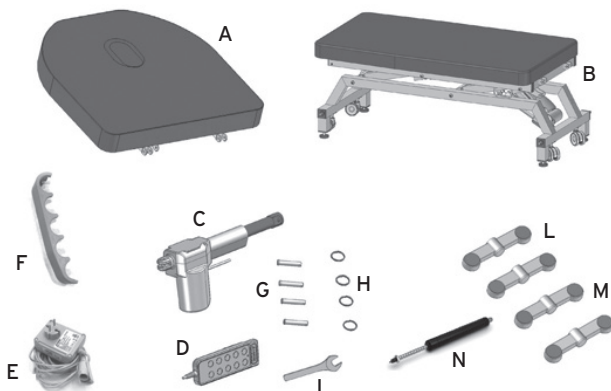

Description

- A. Padded headrest (only on MI38X-MI39X models)
- B. Padded examination bed
- C. Headrest actuator (only on MI380X-MI381X-MI390X-MI391X models)
- D. Remote control (only on MI37XX-MI380X-MI381X-MI390X-MI391X models)
- E. Power supply (only on MI37XX-MI380X-MI381X-MI390X-MI391X models)
- F. Plastic holder for electric connections (only on MI37XX-MI380X-MI381X-MI390X-MI391X models)
- G. Linchpins to assemble headrest and actuator (only on MI38X-MI39X models)
- H. Ring shape stoppers (only on MI38X-MI39X models)
- I. Tool for tips height regulation
- L. Double pedal system - left side (only on MI371X-MI381X-MI386X-MI391X-MI396X models)
- M. Double pedal system - right side (only on MI371X-MI381X-MI386X-MI395X-MI396X models)
- N. Gas spring for headrest (only on MI385X-MI386X-MI395X-MI396X models)

8. ASSEMBLING



WARNING!

Perform these operations with an operator aid, be careful to avoid personal injuries or property damages during bed movements

8.1 Bed assembling

- Remove the product from the packaging and make sure that the content matches the model you requested and that the parties have not been damaged during transport. In the contrary case contact your dealer immediately
- Proceed with the assembling of the headrest (only for MI38XX-MI39XX models) and the actuator to the bed frame using the accessory kit of pins (REF.G), secure them with the ring shape pins (REF.H) as shown in Fig.1

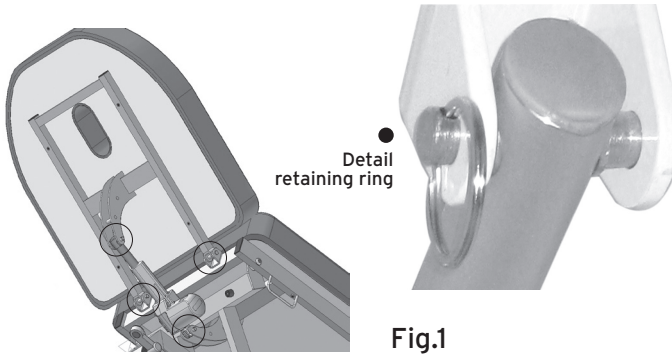

8.2 Pedal assembling (only for MI371X-MI381X-MI386X-MI391X-MI396X)

Assemble the pedal control wheel (REF.L) with the letter reference on same pedal (L = left, R = right) arranging them as in Fig.2

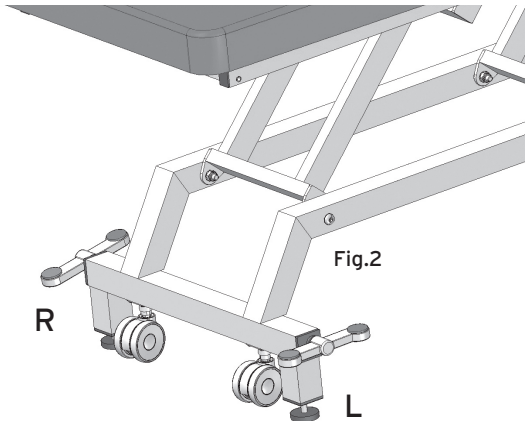

8.3 Actuator connection (only for MI37XX-MI380X-MI381X-MI390X-MI391X)

- Connect the actuator of the headrest and the remote control as shown in Fig.3

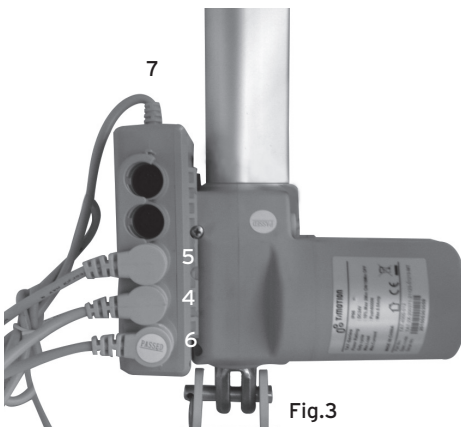

Model with
TC14 CONTROL BOX

Rif.4 Connection for headrest actuator
Rif. 5 Connection for elevation actuator
Rif.6 Connection for remote control
Rif.7 Connection for power supply cable

- Block the connectors on the control box with the plastic cable holder ref.A in Fig.4

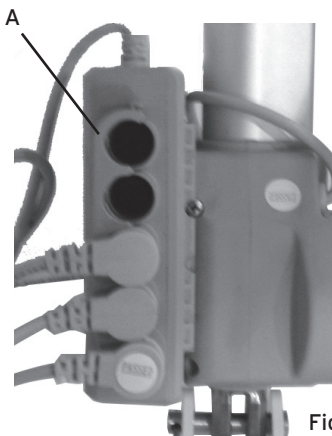

Fig. 4

- Foot tips adjustment



Fig.5

Proceed with the adjustment of the legs in such a way that the mechanism for pedal control of the wheels can easily work. To this end, adjust the height of the foot tip in such a way that the distance shown in the figure does not exceed 10mm (Fig.5)

THE BED IS CORRECTLY ASSEMBLED AND READY FOR USE

8.4 Electric assembling the footswitch MR320-321 (optional for MI37XX-MI380X-MI381X-MI390X-MI391X)

TC14 CONTROL BOX

- Remove the cable holder
- Disconnect the connector of the remote control (if already installed) and connect the Y cable provided
- Insert the cable holder again to block the connectors



Fig.6

- Fix the Y cable in the 2 holes on the leg of the bed with 2 M5 screws (Fig.6)
- Connect the remote control connector to one of the inputs on the adaptor and the foot switch connector to the other input (they are interchangeable). (Fig.7)

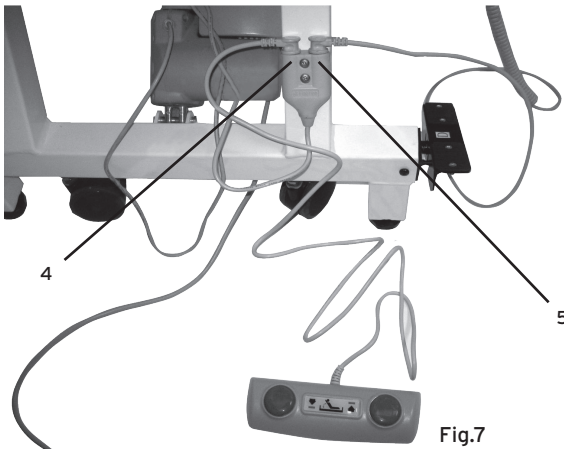

Rif.4 Foot switch connection

Rif.5 Remote control connection

THE KIT IS CORRECTLY ASSEMBLED AND READY FOR USE

8.5 Paper roll holder MIA391 (for MI370X-MI371X), MIA392 (for MI380X-MI381X-MI385X-MI386X) and MIA393/MIA394 (for MI390X-MI391X-MI395X-MI396X assembling (optional))

Fix the two brackets on the end of the bed frame using 4 screws in the kit. Connect the holder tube with the two knobs supplied, as shown in Fig.8

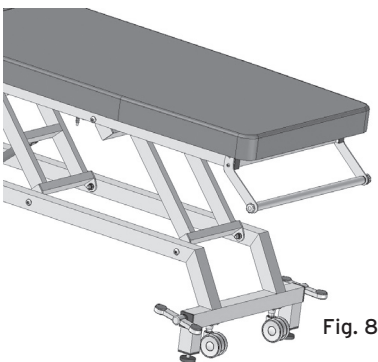

Fig. 8

THE KIT IS CORRECTLY ASSEMBLED AND READY FOR USE

9. BEFORE USE

- Always check the state of wear of the mechanical parts in order to ensure a use of the device in total safety for people and things
- Check for proper assembly of the device with particular attention to the pins and locking clips of the headboard, actuators and mechanical joints in general

10. WARNINGS FOR A CORRECT USE

- Before making any adjustment on the bed make sure that this is in a stable position on the legs;
- Before cleaning or maintaining operations or simply move the bed disconnect the plug of the mains voltage;
- Do not use power strips or extension cords
- Do not connect to the device any electrical device not covered by the normal operation



WARNING!

Do not sit with the weight weighing all on the head, since the maximum declared load for the bed is to be understood "evenly distributed on its surface"; otherwise the frame could be seriously and irreparably damaged. Moretti Spa declines any liability for damages arising from improper use and/or other than that reported in this user manual.

11. HOW TO USE

11.1 Electric models (MI37X-MI380X-MI381X-MI390X-MI391X)

Before each use connect the charger/adaptor cord to the wall outlet.
Use the remote control to set the bed height and the headrest position.

11.2 Hydraulic/gas spring models (MI39XX)

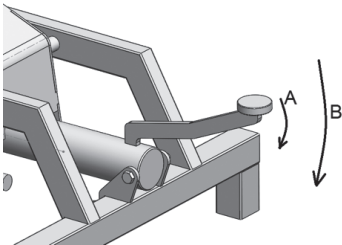

Push the pedal several times to increase the height of the bed as shown in Fig.9 (ref.A), keep pushing deep the pedal to decrease the height of the bed (ref. B).
To set the headrest position, push the release lever located under the headrest.

12. USE THE REMOTE CONTROL (ONLY FOR MI37X-MI380X-MI381X-MI390X-MI391X)

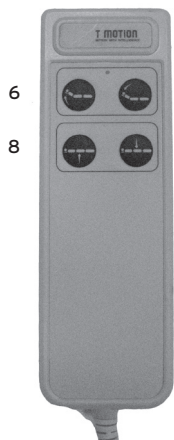

- 6 7
8 9
- Rif.6 Raise head section (only for MI380X-MI381X-MI390X-MI391X)
Rif.7 Lower head section (only for MI380X-MI381X-MI390X-MI391X)
Rif.8 Raise bed
Rif.9 Lower bed

NOTE The yellow Led indicates the remote control is working

12.1 Castors use (only for MI371X-MI381X-MI386X-MI391X-MI396X)



WARNING!

- Before moving the bed, always unplug the supply cable
- Do not move the bed with patients on board

These models of beds have 4 swivel wheels to facilitate movement.

The system of wheels has been studied to ensure a fast and easy intervention through a pedal control. When it is desired to move the bed is sufficient to press with a foot the two pedals on the same side of the bed (right or left) in such a way that the bed is lifted by the supporting feet. Move the bed to the desired location, then press the footrests to lower the wheels and replace the bed on its feet so that it is stable.

12.2 Electrical footswitch MR320-MR321 use (optional)



10



11

Rif.10 **MR320** Footswitch for head section elevation (only for MI38XX)

Rif.11 **MR319 (per MI37XX) / MR321** Footswitch for bed elevation

The two models of electric footswitches differ only in the function that go to activate

1. To lift press with your foot the arrow up (or the head of the bed)
2. To lower press with your foot the arrow down (or the head of the bed)

NOTE To assembly the electric footswitch (MR320 or MR321), refer to section "ASSEMBLING " of this instruction manual

13. MAINTENANCE

The SKEMA devices by MORETTI are checked carefully and supplied with EC mark, once launched on the market. For the safety of the patient and the doctor we recommend to check the suitability of your product at least once a year.

For periodic inspection we refer to the check of the following parts:

- The supporting frame of the bed and the lifting mechanism with their fittings, safety devices
- Check installation and operation of the control mechanism wheels
- Check the integrity of cables and plugs
- Check all welding points

If a repair is needed, please use only approved parts and accessories

14. CLEANING AND DISINFECTION

14.1 Cleaning

Use a damp cloth and mild soap. Then dry thoroughly before use

Use water at a temperature not exceeding 30° C

Do not to use washing machines jet of water and steam

14.2 Disinfection

If you need to disinfect the device use a common disinfectant cleaner

NOTE Never use acids, alkalis or solvents such as acetone

15. CONDITIONS OF DISPOSAL

15.1 General conditions of disposal

In case of disposal don't use the inserting container for municipal waste. We recommend to dispose the beds in the appropriate disposal areas for recycling

15.2 Correct treatment of electrical parts

(Directive 2012/19/UE)

At the end of its life, the product must not be disposed of along with other domestic waste. The users must dispose of this equipment by bringing it to a specific recycling point for electric and electronic equipment or at retailers that provide this service. By ensuring these batteries are disposed of correctly, you will help prevent potentially negative consequences for the environment and human health which could otherwise be caused by inappropriate waste handling of the battery. To remark the need to dispose of electrical equipment separately, the products is marked with crossed mobile waste bin

16. DECLARATION OF ELECTROMAGNETIC COMPATIBILITY

16.1 Guidance and Manufacturer's Declaration - Electromagnetic Emissions

This device is intended for use in the electromagnetic environment specified below. The user of this device should make sure it is used in such an environment.

ENGLISH

| EMISSIONS TEST | COMPLIANCE | ELECTROMAGNETIC ENVIRONMENT - GUIDANCE |
|--|------------|--|
| RF emissions CISPR 11 | Group 1 | The device uses RF energy only for its internal function. Therefore, its RF emissions are very low and are not likely to cause any interference in nearby electronic equipment |
| RF emissions CISPR 11 | Class B | The device is suitable for use in all establishments, including domestic establishments and those directly connected to the public low-voltage power supply network |
| Harmonic emissions IEC61000-3-2 | Class A | |
| Voltage fluctuations / Flicker emissions IEC61000-3-3 | Complies | |
| <p>⚠ Warning:</p> <p>1. The device should not be used adjacent to or stacked with other equipment. If adjacent or stacked use is necessary, the device should be observed to verify normal operation in the configuration in which it will be used.</p> <p>2. Use of accessories, transducers and cables other than those specified or provided by the manufacturer of this equipment could result in increased electromagnetic emissions or decreased electromagnetic immunity of this equipment and result in improper operation.</p> <p>3. Portable RF communications equipment (including peripherals such as antenna cables and external antennas) should be used no closer than 30 cm (12 inches) to any part of the pump, including cables specified by the manufacturer. Otherwise, degradation of the performance of this equipment could result.</p> | | |

16.2 Guidance and Manufacturer's Declaration - Electromagnetic Immunity

This device is intended for use in the electromagnetic environment specified below. The user of this device should make sure it is used in such an environment.

| Basic EMC standard | Immunity Test Levels | | Compliance Levels | Electromagnetic Environment-Guidance |
|---|---|-----------------------------|--|---|
| | Professional healthcare facility environment | HOME HEALTHCARE ENVIRONMENT | | |
| Electrostatic Discharge (ESD) IEC61000-4-2 | ±8kV contact ±15kV air | | ±8kV contact ±15kV air | Floors should be wood, concrete or ceramic tile. If floors are covered with synthetic material, the relative humidity should be at least 30 %. |
| Electrical fast transient/ burst IEC61000-4-4 | ±2kV for power supply line ±1kV for input/output line | | ±2kV for power supply line ±1kV for input/output line | Mains power quality should be that of a typical commercial or hospital environment |
| Surge IEC61000-4-5 | ± 1 kV line(s) to line(s) ± 2 kV line(s) to earth | ± 1 kV line(s) to line(s) | ± 1 kV line(s) to line(s) | Mains power quality should be that of atypical commercial or hospital environment. |
| Voltage dips, short interruptions and voltage variations on power supply input lines IEC61000-4-11 | Voltage Dips: i) 100% reduction for 0.5 period, ii) 100% reduction for 1 period, iii) 30% reduction for 25/30 period, Voltage Interruptions: 100% reduction for 250/300 period | | 230V | Mains power quality should be that of a typical commercial or hospital environment. If the user of this device requires continued operation during power mains interruptions, it is recommended that the device be powered from an uninterruptible power supply or a battery. |
| Power frequency (50/60Hz) magnetic field IEC61000-4-8 | 30 A/m | 30 A/m | 30 A/m | Power frequency magnetic fields should be at levels characteristic of a typical location in a typical commercial or hospital environment. |

| Basic EMC standard | Immunity Test Levels | | Compliance Levels | Electromagnetic Environment-Guidance |
|---|--|---|-------------------|--|
| | Professional healthcare facility environment | HOME HEALTHCARE ENVIRONMENT | | |
| Conducted RF IEC 61000-4-6 | 3 Vrms 0,15 MHz - 80 MHz 6 Vrms in ISM bands between 0,15 MHz and 80 MHz 80 % AM at 1 kHz | 3 Vrms 0,15 MHz - 80 MHz 6 Vrms in ISM and amateur radio bands between 0,15 MHz and 80 MHz 80 % AM at 1 kHz | 6Vrms | Portable and mobile RF communications equipment should be used no closer to any part of this device, including cables, than there commended separation distance calculated from the equation applicable to the frequency of the transmitter. Recommended separation distance $=\sqrt{P} 150\text{kHz to } 80\text{MHz}$ $=0.6\sqrt{P} 80\text{MHz to } 800\text{MHz}$ $=1.2\sqrt{P} 800\text{ MHz to } 2.7\text{G MHz}$ Where P is the maximum output power rating of the transmitter in watts (W) according to the transmitter manufacturer and d is the recommended separation distance in meters (m). b Field strengths from fixed RF transmitters, as determined by an electromagnetic site survey, a should be less than the compliance level in each frequency ranged. Interference may occur in the vicinity of equipment marked with the following symbol:  |
| Radiated RF EM Fields IEC61000-4-3 | 3 V/m 80 MHz to 2.7 GHz 80 % AM at 1 kHz 385-6000 MHz, 9-28V/m, 80% AM(1kHz) pulse mode and other modulation | 10 V/m 80 MHz to 2,7 GHz 80 % AM at 1 kHz 385-6000 MHz, 9-28V/m, 80% AM(1kHz) pulse mode and other modulation | 10V/m | |
| NOTE 1: UT is the a.c. mains voltage prior to the application of the test level NOTE2: At 80 MHz and 800 MHz, the higher frequency range applies. NOTE 2: These guidelines may not apply in all situations. Electromagnetic propagation is affected by absorption and reflection from structures, objects and people | | | | |
| a)Field strengths from fixed transmitters, such as base stations for radio (cellular/cordless) telephones and land mobile radios, amateur radio, AM and FM radio broadcast and TV broadcast cannot be predicted theoretically with accuracy. To assess the electromagnetic environment due to fixed RF transmitters, an electromagnetic site survey should be considered. If the measured field strength in the location in which the device is used exceeds the applicable RF compliance level above, the device should be observed to verify normal operation. If abnormal performance is observed, additional measures may be necessary, such as reorienting or relocating the device. b) Over the frequency range 150 kHz to 80 MHz, field strengths should be less than 10 V/m. | | | | |

16.3 Recommended separation distances between portable and mobile RF communications equipment and this device

This device is intended for use in an electromagnetic environment in which radiated RF disturbances are controlled. The customer or the user of this device can help prevent electromagnetic interference by maintaining a minimum distance between portable and mobile RF communications equipment (transmitters) and this device as recommended below, according to the maximum output power of the communications equipment.

| Rated maximum output power of transmitter W | Separation distance according to frequency of transmitter m | | |
|---|---|--------------------------|-----------------------------|
| | 150 kHz to 80 MHz =√P | 80 MHz to 800 MHz =0.6√P | 800 MHz to 2,7 GHz d =1.2√P |
| 0.01 | 0.1 | 0.06 | 0.12 |
| 0.1 | 0.31 | 0.19 | 0.38 |
| 1 | 1 | 0.6 | 1.2 |
| 10 | 3.1 | 1.9 | 3.8 |
| 100 | 10 | 6 | 12 |

For transmitters specified for a maximum output not listed above, the recommended separation distance "d" in meters (m) can be calculated using the equation applicable to the frequency of the transmitter, where "P" is the maximum rated power d ' transmitter output in Watts (W) according to the transmitter manufacturer.

NOTE 1 At 80MHz and 800MHz if the high frequency range is applied

NOTE 2: Guideline question for not applying in all situations. Electromagnetic propagation is affected by absorption and reflection from structures, objects and people

17. SPARE PARTS AND ACCESSORIES

For spare parts and accessories refer to Moretti main catalogue





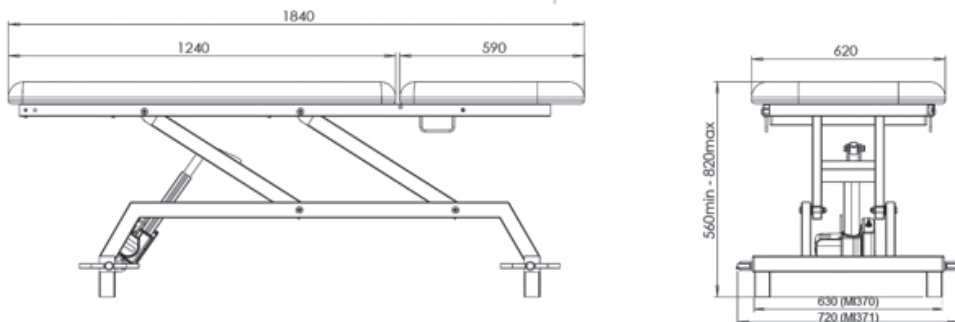

- MR319** Electric footswitch for bed elevation for MI37XX
- MR320** Electric footswitch for headrest elevation (for MI380X-MI381X-MI390X-MI391X)
- MR321** Electric footswitch for bed elevation (for MI37XX-MI380X-MI381X-MI390X-MI391X)
- MIA391** Paper roll holder 60cm wide for MI37XX
- MIA392** Paper roll holder 60cm wide for MI380X-MI381X-MI385X-MI386X
- MIA393** Paper roll holder 60cm wide for MI390X-MI391X-MI395X-MI396X
- MIA394** Paper roll holder 80cm wide for MI390X-MI391X-MI395X-MI396X

18. TECHNICAL FEATURES

18.1 Dimension and weight MI370X-MI371X







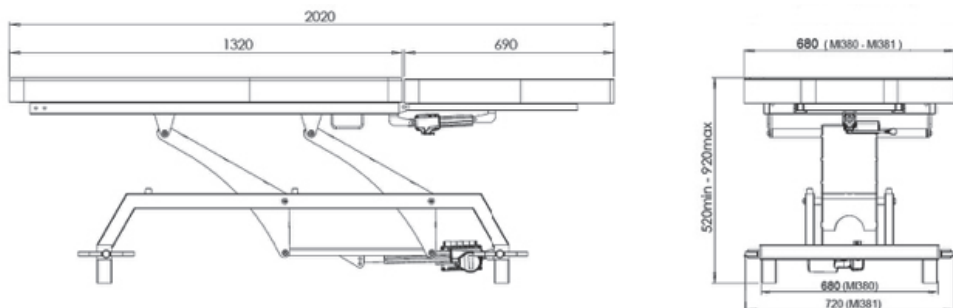

| | |
|-------------------------|-------------|
| Dimension (MI370): | mm 1840x630 |
| Dimension (MI371): | mm 1840x720 |
| Min height: | mm 560 |
| Max height: | mm 820 |
| Head section max angle: | 60° |

| | | | |
|---|--|---|---|
|  Pack size MI370-MI371 |  L: 1850 mm |  P: 730 mm |  H: 570 mm |
|  Pack weight MI372-MI371 | 54 kg | | |
|  Bed weight MI370-MI371 | 48 kg | | |
|  Max weight | 150 kg | | |

18.2 Dimension and weight MI380X - MI381X







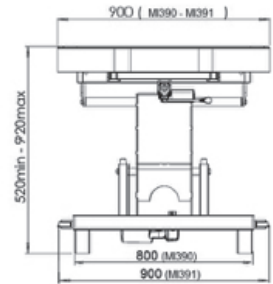
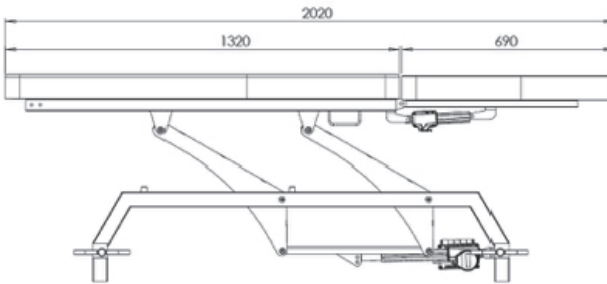

| | |
|-------------------------|-------------|
| Dimension (MI380X): | mm 2020x680 |
| Dimension (MI381X): | mm 2020x720 |
| Min height: | mm 520 |
| Max height: | mm 920 |
| Head section max angle: | 60° |

| | | | |
|---|--|---|---|
|  Pack size MI380-MI381 |  L: 1785 mm |  P: 730 mm |  H: 535 mm |
|  Pack weight MI380-MI381 | 68 kg | | |
|  Bed weight MI380-MI381 | 60 kg | | |
|  Max weight | 200 kg | | |

18.3 Dimension and weight MI390X - MI391X



Dimension (MI390X): mm 2020x800
 Dimension (MI391X): mm 2020x900
 Min height: mm 520
 Max height: mm 920
 Head section max angle: 60°





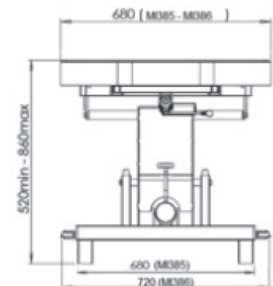
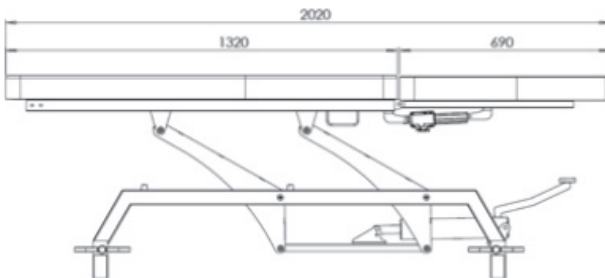

| | | | |
|--|--|---|---|
|  Pack size MI390-MI391 |  L: 2040 mm |  P: 940 mm |  H: 535 mm |
|  Pack weight MI390-MI391 | 86 kg | | |
|  Bed weight MI390-MI391 | 75 kg | | |
|  Max weight | 200 kg | | |

18.4 Dimension and weight MI385X - MI386X



Dimension (MI385X): mm 2020x680
 Dimension (MI386X): mm 2020x720
 Min height: mm 520
 Max height: mm 860
 Head section max angle: 60°





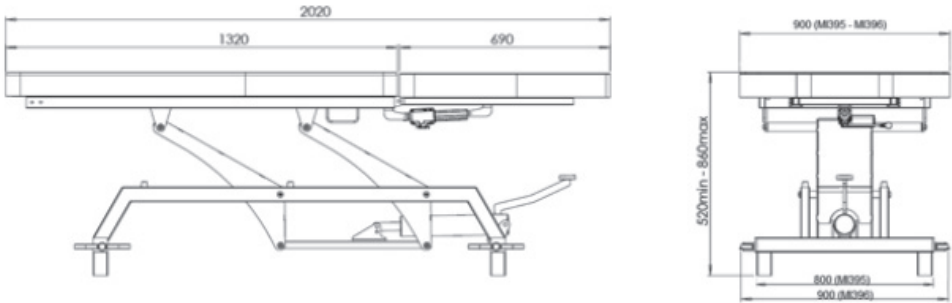

ENGLISH

| | | | |
|---|--|---|---|
|  Pack size MI385-MI386 |  L: 2040 mm |  P: 730 mm |  H: 535 mm |
|  Pack weight MI385-MI386 | 69 kg | | |
|  Bed weight MI385-MI386 | 61 kg | | |
|  Max weight | 180 kg | | |

18.5 Dimension and weight MI395X - MI396X



Dimension (MI395X): mm 2020x900
 Dimension (MI396X): mm 2020x900
 Min height: mm 520
 Max height: mm 860
 Head section max angle: 60°

| | | | |
|---|--|---|---|
|  Pack size MI395-MI396 |  L: 2040 mm |  P: 940 mm |  H: 535 mm |
|  Pack weight MI395-MI396 | 89 kg | | |
|  Bed weight MI395-MI396 | 78 kg | | |
|  Max weight | 180 kg | | |

18.6 Technical specifications

| | |
|--|--|
| Required force to operate the controls on the remote control | 5 N |
| Required force to push the elevation pedal (MI39X) | 30N |
| Input | 220-240V AC 50Hz, 600 mA |
| Output | 24 Vdc |
| Protection Class | IP 54 |
| Noise level | < 45 DB |
| Insulation Class | 2 Class |
| Used materials for bed mainframe | Varnished steel frame, foam bed cover in PVC |

19. TROUBLE SHOOTING

| SYMPTOM | CAUSES | SOLUTION |
|---|---|--|
| No control running | <ol style="list-style-type: none"> 1. The plug is not connected 2. The remote control is not connected to the control unit 3. The remote control or the control unit are defective | <ol style="list-style-type: none"> 1. Connect the plug 2. Check and connect the remote control 3. Contact the service center for a more precise diagnosis |
| The head-section elevation doesn't work | <ol style="list-style-type: none"> 1. The head-section actuator is not connected to the control unit 2. The actuator or the remote control are defective | <ol style="list-style-type: none"> 1. Check and connect the elevator to the control unit 2. Contact the service center for a more precise diagnosis |
| The bed elevation doesn't work | <ol style="list-style-type: none"> 1. The bed actuator is not connected to the control unit 2. The actuator or the remote control are defective | <ol style="list-style-type: none"> 1. Check and connect the actuator to the control unit 2. Contact the service center for a more precise diagnosis |
| The footswitch doesn't work | <ol style="list-style-type: none"> 1. The footswitch is not connected to the Y cable 2. The Y cable is not connected to the control unit 3. The control unit or the actuator are defective | <ol style="list-style-type: none"> 1. Check and connect the footswitch to the Y cable 2. Connect the Y cable to the control unit 3. Contact the service center for a more precise diagnosis |

20. WARRANTY

Moretti products are guaranteed from material or manufacturing faults for 2 years from the purchasing date, except possible exclusion or restriction as follows. The warranty shall not be applied in the possible damages caused by improper use, abuse or alteration, and the warranty will not be valid if the instructions for use are not strictly adhered to. The correct intended use is specified in this manual.

Moretti is not responsible for consequent damages, personal injuries or whatever caused by or in relation to wrong installation or improper use.

Moretti warranty does not cover damages resulting from: natural disaster, not authorized maintenance or repairs, faults caused by problems on electricity supply (when necessary), use of spare parts not covered by Moretti, improper use, not authorized alteration, shipment damages (different from original Moretti shipment), or in case of insufficient maintenance as indicated in the manual.

The warranty doesn't cover components subject to wear and tear during the correct use of the device.

21. REPAIRING

21.1 Warranty repair

If a Moretti item presents material or manufacturing faults during the warranty period, Moretti will confirm with customer if the fault can be covered from warranty. Moretti, at its unquestionable discretion, can repair or replace the item, by a Moretti dealer or to Moretti headquarters. Labor cost can be charged to Moretti if the repair is covered by warranty. A repair or a replacement doesn't extend the warranty

21.2 Repair not covered by warranty

A product out of warranty can be sent after Moretti authorization. The labor and shipping costs for good out of warranty are to be paid by the customer or by the dealer. The repairs are guaranteed for 6 months from the good received

21.3 Non-defective devices

The customer will be informed if, after the device return and examination, Moretti declares that the device is not faulty. In this case the good will be sent back to customer, the shipping charge will be paid by the customer

22. SPARE PARTS

The original Moretti spare parts are guaranteed for 6 months from the receiving date

23. EXEMPT CLAUSES

Moretti does not offer any other declarations, explicit or implicit warranty or conditions, including possible declarations, warranties or conditions of merchantability, fitness for a specific purpose, non infringement and non interference, all but what expressly specified in this warranty. Moretti does not guarantee the nonstop and faultless usage.

The duration of possible implicit warranties which can be imposed by the law is limited by the warranty period, in the limits of law. Some states or countries don't allow limiting the implicit warranty or the exclusion or the limitation for accidental damages. In such countries, some of those exclusions or limitation may not be applied to the user. The present warranty may be modified without prior notification.



WARRANTY CERTIFICATE

ENGLISH

Product _____

Purchased on (date) _____

Retailer _____

Address _____ **Town/city** _____

Sold to _____

Address _____ **Town/city** _____



Via Bruxelles, 3 - Meleto 52022 Cavriglia (Arezzo) Tel. +39 055 96 21 11

www.morettispa.com email: info@morettispa.com

MADE IN ITALY

MORETTI S.P.A.

Via Bruxelles, 3 - Meleto
52022 Cavriglia (Arezzo)

Tel. +39 055 96 21 11
Fax. +39 055 96 21 200

www.morettispa.com
info@morettispa.com

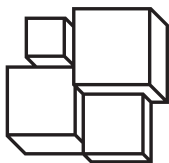

SKEMA[®]FORM

MA MI37XX - MI38XX - MI39XX 02 A _ ESP_09-2020

**CAMA PARA CONSULTAS
MÉDICAS PROFESIONAL**

MANUAL DE INSTRUCCIONES



ÍNDICE

| | | |
|---|--|---------------|
| 1. CÓDIGOS | | PAG.3 |
| 2. INTRODUCCIÓN | | PAG.3 |
| 3. FINALIDAD | | PAG.3 |
| 4. DECLARACIÓN UE DE CONFORMIDAD | | PAG.3 |
| 4.1 Normas y directivas de referencia | | pag. 4 |
| 5. ADVERTENCIAS GENERALES | | PAG.4 |
| 6. SÍMBOLOS | | PAG.4 |
| 7. DESCRIPCIÓN GENERAL | | PAG.5 |
| 7.1 Vista y descripción de las partes..... | | pag. 5 |
| 8. MONTAJE | | PAG.6 |
| 8.1 Montaje de la cama | | pag. 6 |
| 8.2 Montaje de los estribos | | pag. 6 |
| 8.3 Conexión eléctrica | | pag. 7 |
| 8.4 Montaje del accesorio kit mando a pedal eléctrico..... | | pag. 8 |
| 8.5 Montaje del accesorio portarrollo | | pag. 9 |
| 9. ANTES DE CADA USO | | PAG.9 |
| 10. ADVERTENCIAS PARA EL USO | | PAG.9 |
| 11. MODO DE USO | | PAG.10 |
| 11.1 Modelos con accionamiento eléctrico..... | | pag. 10 |
| 11.2 Modelos con accionamiento hidráulico/neumático | | pag. 10 |
| 12. USO DEL MANDO A DISTANCIA (PARA MI37XX-MI380X-MI381X-MI390X-MI391X) . | | PAG.10 |
| 12.1 Uso de las ruedas..... | | pag. 10 |
| 12.2 Uso del pedal eléctrico..... | | pag. 11 |
| 13. MANTENIMIENTO | | PAG.11 |
| 14. LIMPIEZA Y DESINFECCIÓN | | PAG.11 |
| 14.1 Limpieza..... | | pag. 11 |
| 14.2 Desinfección | | pag. 11 |
| 15. CONDICIONES DE ELIMINACIÓN | | PAG.12 |
| 15.1 Condiciones de eliminación generales | | pag. 12 |
| 15.2 Advertencias para la eliminación correcta del producto según la directiva europea 2012/19/UE:..... | | pag. 12 |
| 16. DECLARACIÓN DE COMPATIBILIDAD ELECTROMAGNÉTICA | | PAG.12 |
| 16.1 Guía y declaración del fabricante - emisiones electromagnéticas | | pag. 12 |
| 16.2 Guía y declaración del fabricante - inmunidad electromagnética | | pag. 13 |
| 16.3 Distancias de separación recomendadas entre los equipos de comunicación portátiles y móviles y el sistema Lytus | | pag. 15 |
| 17. REPUESTOS Y ACCESORIOS | | PAG.15 |
| 18. CARACTERÍSTICAS TÉCNICAS | | PAG.16 |
| 18.1 Medidas y peso MI370X - MI371X | | pag. 16 |
| 18.2 Medidas y peso MI380X - MI381X | | pag. 16 |
| 18.3 Medidas y peso MI390X - MI391X..... | | pag. 17 |
| 18.4 Medidas y peso MI385X - MI386X | | pag. 17 |
| 18.5 Medidas y peso MI395X - MI396X..... | | pag. 18 |
| 18.6 Especificaciones técnicas | | pag. 19 |
| 19. RESOLUCIÓN DE PROBLEMAS | | PAG.19 |
| 20. GARANTÍA | | PAG.20 |
| 21. REPARACIONES | | PAG.20 |
| 21.1 Reparación en garantía | | pag. 20 |
| 21.2 Reparación de un producto no cubierto por la garantía..... | | pag. 20 |
| 21.3 Productos no defectuosos | | pag. 20 |
| 22. REPUESTOS | | PAG.20 |
| 23. CLÁUSULAS EXONERATIVAS | | PAG.21 |



REGLAMENTO (UE) 2017/745 DEL PARLAMENTO EUROPEO Y DEL CONSEJO
del 5 de abril de 2017 sobre los productos sanitarios

1. CÓDIGOS

- MI370X** Cama para consultas médicas eléctrica ancho 62 cm (LYTUS)
MI371X Cama para consultas médicas eléctrica ancho 62 cm con ruedas (LYTUS)
MI380X Cama para consultas médicas eléctrica ancho 68 cm (LYTUS)
MI381X Cama para consultas médicas eléctrica ancho 68 cm con ruedas (LYTUS)
MI385X Cama para consultas médicas hidráulica ancho 68 cm (LYTUS)
MI386X Cama para consultas médicas hidráulica ancho 68 cm con ruedas (LYTUS)
MI390X Cama para consultas médicas eléctrica ancho 90 cm (LYTUS)
MI391X Cama para consultas médicas eléctrica ancho 90 cm con ruedas (LYTUS)
MI395X Cama para consultas médicas hidráulica ancho 90 cm (LYTUS)
MI396X Cama para consultas médicas hidráulica ancho 90 cm con ruedas (LYTUS)

X: Indica el color del revestimiento

2. INTRODUCCIÓN

Gracias por haber elegido una cama para consultas médicas de la línea SKEMA fabricada por Moretti. Las camas para consultas médicas Moretti han sido diseñadas y realizadas para satisfacer todas tus exigencias, con un uso práctico y seguro. Este manual de instrucciones contiene algunas sugerencias que le permitirán usar correctamente el equipo que Ud. ha elegido, así como valiosos consejos para su seguridad.

Se recomienda leer el manual completo detenidamente antes de utilizar la cama para consultas médicas. En caso de dudas contacte con el distribuidor, que estará en condiciones de brindarle ayuda y consejos.

3. FINALIDAD

Las camas para consultas médicas profesionales Moretti se utilizan para sostener al paciente durante tratamientos fisioterapéuticos y consultas médicas de breve duración.

¡ATENCIÓN!



- Está prohibido utilizar el producto con fines diferentes de aquel definido en este manual
- Moretti S.p.A. declina toda responsabilidad respecto de los daños derivados de un uso incorrecto del producto o diferente de aquel indicado en el presente manual
- El fabricante se reserva el derecho de aportar modificaciones al producto y a este manual sin aviso previo, con propósitos de mejora.

4. DECLARACIÓN UE DE CONFORMIDAD

MORETTI SpA declara bajo su exclusiva responsabilidad que los productos fabricados e introducidos en el mercado por la misma MORETTI SpA y que forman parte de la familia de las CAMAS PARA CONSULTAS MÉDICAS PROFESIONALES - LYTUS son conformes con las disposiciones del reglamento 2017/745 sobre los PRODUCTOS SANITARIOS del 5 de abril de 2017.

Para ello, MORETTI SpA garantiza y declara bajo su exclusiva responsabilidad los siguientes puntos:

1. Los productos en cuestión cumplen con los requisitos generales de seguridad y prestación establecidos por el anexo I y el anexo IV del reglamento 2017/745.
2. Los productos en cuestión NO SON INSTRUMENTOS DE MEDICIÓN.
3. Los productos en cuestión NO ESTÁN DESTINADOS A INVESTIGACIONES CLÍNICAS.
4. Los productos en cuestión se comercializan en presentación NO ESTÉRIL.

5. Los productos en cuestión deben considerarse de clase I en conformidad a lo establecido en el anexo VIII del mismo Reglamento.
6. MORETTI SpA mantiene y pone a disposición de las Autoridades Competentes, por 10 años desde la fecha de fabricación del último lote, la documentación técnica que comprueba la conformidad con el reglamento 2017/745.

Nota: Los códigos completos de producto, el código de registro del fabricante (SRN), el código UDI-DI de base y eventuales referencias a normas utilizadas figuran en la Declaración de Conformidad UE que MORETTI SPA emite y pone a disposición a través de sus propios canales.

4.1 Normas y directivas de referencia

Para garantizar los estándares de seguridad para los usuarios, Moretti S.p.A. prueba y respeta la norma:











- UNI EN 12182 (PRODUCTOS PARA LA ASISTENCIA DE PERSONAS DISCAPACITADAS)
- UNI CEI EN 60601-2-52:2016 Equipo electromédico. Parte 2-52. Requisitos especiales para la seguridad básica y el funcionamiento esencial de las camas médicas

5. ADVERTENCIAS GENERALES

Para el uso correcto del producto, leer atentamente el siguiente manual

- Mantener el producto embalado lejos de cualquier fuente de calor, ya que el embalaje es de cartón
- La vida útil del producto depende del desgaste de las partes no reparables o sustituibles, pero no debe superar los 10 años
- Prestar siempre mucha atención a la presencia de partes móviles que podrían atrapar las manos y causar lesiones personales.
- Prestar atención especialmente si hay niños presentes
- El usuario o paciente deberá señalar cualquier incidente grave ocurrido en relación con el producto al fabricante y a la autoridad competente del país miembro donde se encuentre.

6. SÍMBOLOS

| | |
|--|--|
|  | Código producto |
|  | Identificación unívoca de productos |
|  | Marcado CE |
|  | Fabricante |
|  | Lote de producción |
|  | Leer el manual de instrucciones |
|  | Producto sanitario |
|  | Condiciones de eliminación |
|  | Atención |
|  | Fecha de producción |
|  | Eliminación del producto según la directiva CE/19/2012 |

IP54 

Protección contra el polvo y las salpicaduras de agua



 Parte aplicada de tipo B

 Clase aislamiento II

 Carga máxima permitida

7. DESCRIPCIÓN GENERAL

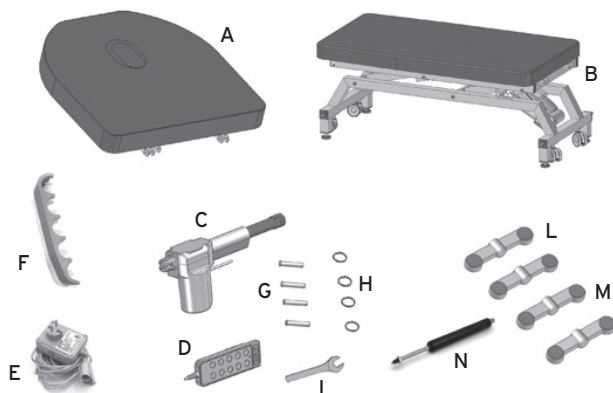
7.1 Vista y descripción de las partes



Lista de las partes

- A. Cabecero con superficie acolchada (sólo para MI38X-MI39X)
- B. Bastidor con superficie acolchada
- C. Actuador cabecero (sólo para MI380X-MI381X-MI390X-MI391X)
- D. Mando a distancia (sólo para MI37XX-MI380X-MI381X-MI390X-MI391X)
- E. Alimentador (sólo para modelos eléctricos MI37XX-MI380X-MI381X-MI390X-MI391X)
- F. Sujetador plástico para conexiones eléctricas (sólo para modelos eléctricos MI37XX-MI380X-MI381X-MI390X-MI391X)
- G. Pernos de ensamblaje de cabecero y actuador (sólo para MI38X-MI39X)
- H. Aro de bloqueo (sólo para MI38X-MI39X)
- I. Llave de "horquilla" para la regulación de los pies
- L. Doble pedal izquierdo (sólo para MI371X-MI381X-MI386X-MI391X-MI396X)
- M. Doble pedal derecho (sólo para MI371X-MI381X-MI386X-MI391X-MI396X)
- N. Actuador a gas para cabecero (sólo para MI385X-MI386X-MI395X-MI396X)

8. MONTAJE



¡ATENCIÓN!

Realizar estas operaciones con la ayuda de otro operador, prestando mucha atención para evitar lesiones físicas y daños materiales durante el desplazamiento de la cama.

8.1 Montaje de la cama

- Abrir la caja de embalaje de la cama y comprobar que el contenido corresponda al modelo pedido y las partes no hayan sufrido daños durante el transporte. En caso contrario, contactar inmediatamente con el revendedor
- Ensamblar el cabecero (sólo para MI38X-MI39X) y el actuador al bastidor utilizando los pernos del kit de accesorios (Ref.G) y bloquearlos con los aros de seguridad (Ref.H) como en la Fig.1

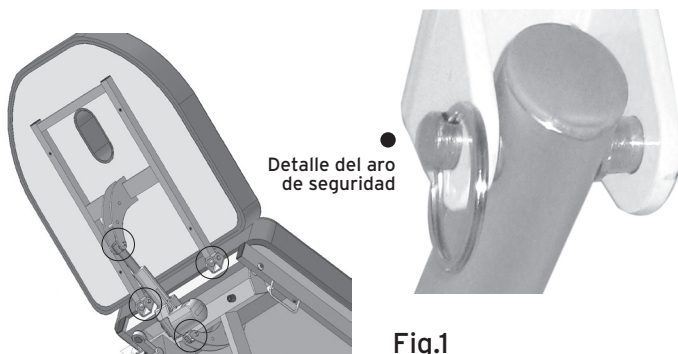

Fig.1

8.2 Montaje de los estribos (sólo para MI371X-MI381X-MI386X-MI391X-MI396X)

- Proceder al montaje de los estribos de mando de las ruedas (Ref.L), respetando la letra de referencia que se encuentra en cada estribo (L= izquierda, R= derecha), disponiéndolos como en la Fig.2

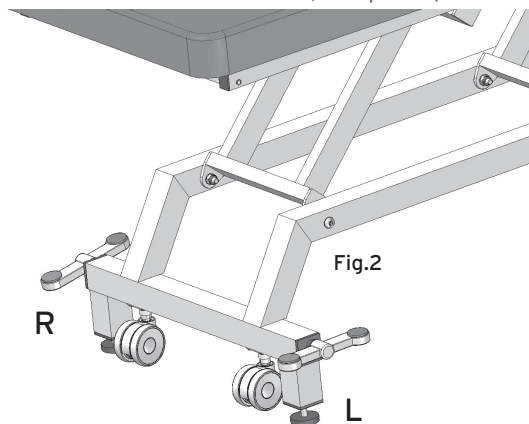

Fig.2

8.3 Conexión eléctrica (sólo para MI37XX-MI380X-MI381X-MI390X-MI391X)

- Pasar a la conexión eléctrica del actuador levanta-cabeza (sólo para MI37XX-MI38XX) y del mando a distancia como se ilustra en la Fig.3

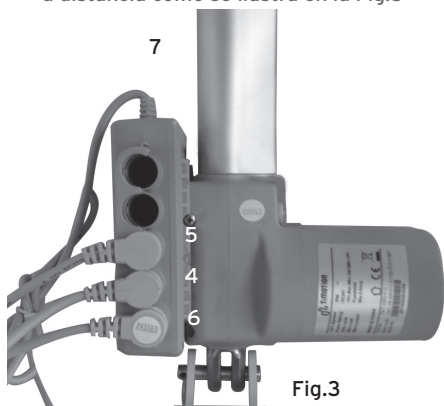

Fig.3

Modelo con CENTRALITA TC14

- Ref.4 Actuador levanta-cabeza
- Ref.5 Actuador elevación
- Ref.6 Mando a distancia
- Ref.7 Cable conexión alimentador

- Bloquear los conectores de la centralita con el sujetador de plástico Ref.A, Fig.4

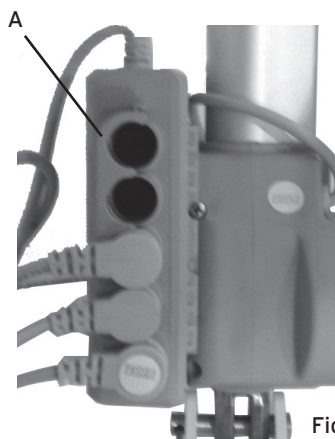

Fig. 4

- Regulación del pie



Fig.5

Regular los pies de manera que el mecanismo de pedal de las ruedas pueda funcionar libremente. Regular la altura del pie de manera que la distancia indicada en la figura no supere los 10mm (Fig.5)

AHORA LA CAMA ESTÁ CORRECTAMENTE ENSAMBLADA Y LISTA PARA USAR

8.4 Montaje del accesorio kit mando a pedal eléctrico MR320-321 (opcional para MI37XX-MI380X-MI381X-MI390X-MI391X)

- Sacar el sujetador de plástico que bloquea los conectores en la centralita
- Desconectar el conector eléctrico del mando a distancia (si se ha instalado) y conectar el conector eléctrico del cable en Y contenido en el kit
- Bloquear los conectores con el sujetador de plástico



Fig.6

- Fijar el cable en Y a la pata de la cama dotada de dos orificios, utilizando dos tornillos M5 (Fig.6)
- Conectar el conector del mando a distancia a una de las dos entradas en el adaptador y el mando de pedal a la otra (Fig.7). Son intercambiables

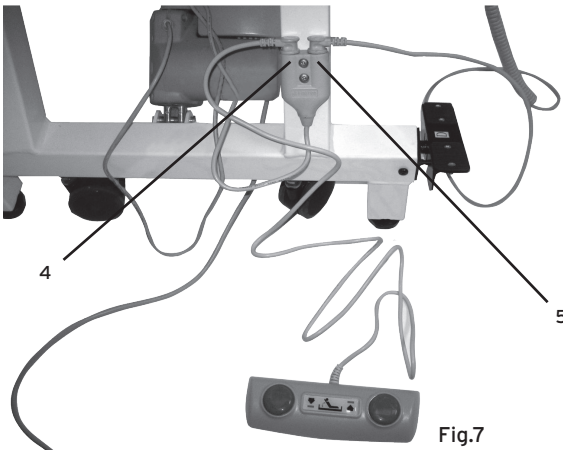

Fig.7

- Ref.4 Conector mando eléctrico a pedal
Ref.5 Conector eléctrico mando a distancia

AHORA EL KIT ESTÁ CORRECTAMENTE ENSAMBLADO Y LISTO PARA USAR

8.5 Montaje del accesorio portarrollo MIA391 (para cama MI370X-MI371X), MIA392 (para cama MI380X-MI381X-MI385X-MI386X) y MIA393/MIA394 (para cama MI390X-MI391X-MI395X-MI396X)
Fijar las dos bridas a la parte terminal del bastidor de la cama utilizando 4 tornillos del kit. Conectar el tubo portarrollo mediante los dos pomos en dotación, como se ilustra en la Fig.8

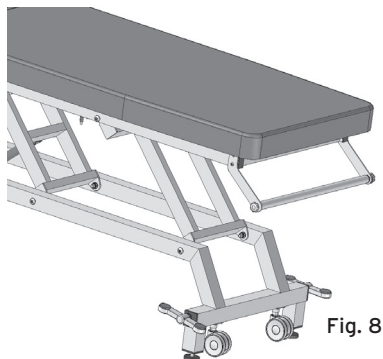

Fig. 8

AHORA EL KIT ESTÁ CORRECTAMENTE ENSAMBLADO Y LISTO PARA USAR

9. ANTES DE CADA USO

- Verificar siempre el desgaste de las partes mecánicas para garantizar el uso seguro del producto, libre de peligros para personas y bienes
- Verificar el correcto ensamblaje del dispositivo prestando atención a los pernos y elementos de bloqueo del cabecero, de los actuadores y de las articulaciones mecánicas en general

10. ADVERTENCIAS PARA EL USO

- Antes de efectuar cualquier regulación en la cama, asegurarse de que se encuentre estable sobre las patas
- Antes de realizar limpieza o mantenimiento o de desplazar la cama, desconectar la clavija de la tensión de red
- No utilizar tomas múltiples móviles adicionales o cables prolongadores
- No conectar a la cama dispositivos eléctricos no previstos para el funcionamiento normal



¡ATENCIÓN!

No sentarse ejerciendo todo el peso sobre el cabecero, ya que la carga máxima de la cama se ejerce "uniformemente distribuida sobre toda la superficie"; en caso contrario, la estructura del bastidor podría dañarse irremediablemente. Moretti S.p.A. declina toda responsabilidad respecto de daños derivados de un uso incorrecto o diferente del indicado en el presente manual de uso.

11. MODO DE USO

11.1 Modelos con accionamiento eléctrico (MI37XX-MI380X-MI381X-MI390X-MI391X)

Antes de cada uso conectar el cable de alimentación eléctrica a la toma de red 220 Vca. Utilizar el mando a distancia en dotación para regular la altura de la cama y la inclinación del cabecero.

11.2 Modelos con accionamiento hidráulico/neumático (MI39XX)

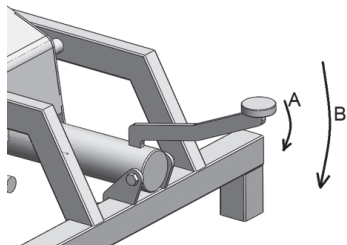

Para levantar la cama, presionar varias veces el pedal de elevación como en la fig. 9 (ref. A); para bajar la cama, presionar a fondo el pedal de elevación (ref. B).

Para reposicionar el cabecero, presionar la palanca de desbloqueo del actuador neumático que se encuentra debajo del cabecero.

12. USO DEL MANDO A DISTANCIA (PARA MI37XX-MI380X-MI381X-MI390X-MI391X)

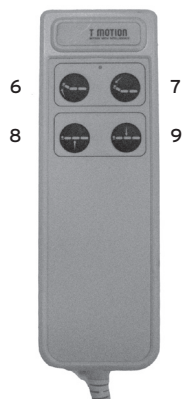

- | | | | |
|---|---|-------|--|
| 6 | 7 | Ref.6 | Tecla de regulación del levanta-cabeza "ARRIBA" (sólo MI380X-MI381X-MI390X-MI391X) |
| 8 | 9 | Ref.7 | Tecla de regulación del levanta-cabeza "ABAJO" (sólo MI380X-MI381X-MI390X-MI391X) |
| | | Ref.8 | Tecla de regulación de la elevación de la cama "ARRIBA" |
| | | Ref.9 | Tecla de regulación de la elevación de la cama "ABAJO" |

Nota El mando a distancia tiene un led luminoso amarillo que se enciende para indicar el estado de accionamiento de una de las teclas

12.1 Uso de las ruedas (sólo modelos MI371X-MI381X-MI386X-MI391X-MI396X)



¡Atención!

- Antes de desplazar la cama, recordar siempre desconectar el cable de alimentación eléctrica de la toma de corriente
- No desplazar la cama con el paciente sobre la cama

Estos modelos de cama tienen 4 ruedas pivotantes para facilitar el desplazamiento.

El sistema de las ruedas ha sido estudiado para garantizar una intervención fácil y rápida a través de un pedal. Cuando se desee desplazar la cama, es suficiente presionar con un pie los dos pedales situados del mismo lado de la cama (derecha o izquierda) para que la cama se levante despegándose de los pies de apoyo. Desplazar cómodamente la cama a la posición deseada, presionar nuevamente los pedales para bajar las ruedas y reposicionar la cama sobre los pies de manera que quede estable.

12.2 Uso del pedal eléctrico MR320-MR321 (opcional)



Ref.10 **MR320** Mando de pedal eléctrico para activar el levanta-cabeza

Ref.11 **MR319 (para MI37XX) / MR321** Mando de pedal eléctrico para activar la elevación de la cama

Los dos modelos de pedal eléctrico difieren entre sí sólo por la función que activan

1. Para levantar, presionar con el pie la flecha hacia arriba (del cabecero o de la superficie de la cama)
2. Para bajar, presionar con el pie la flecha hacia abajo (del cabecero o de la superficie de la cama)

Nota Para el montaje del pedal eléctrico (MR320 o MR321) consultar el apartado “ MONTAJE” de este manual de instrucciones

13. MANTENIMIENTO

Los productos de la línea SKEMA fabricados por Moretti que se introducen en el comercio han sido cuidadosamente controlados y provistos de marca CE.

Para la seguridad del paciente y del médico se recomienda hacer controlar la idoneidad del producto al menos una vez al año.

Por inspección periódica se entiende un examen de las siguientes partes:

- Estructura portante de la cama y mecanismo de elevación, con las correspondientes conexiones, mandos, dispositivos de seguridad
- Controlar el montaje y el funcionamiento del mecanismo de mando de las ruedas
- Verificar la integridad de los cables y las clavijas de red
- Verificar todos los puntos de soldadura

En caso de reparación, utilizar sólo repuestos y accesorios originales

14. LIMPIEZA Y DESINFECCIÓN

14.1 Limpieza

Utilizar exclusivamente un paño húmedo y jabón neutro.

Secar bien antes del uso.

Utilizar agua a una temperatura no superior a 30 °C.

No utilizar máquinas de lavado con chorro de agua o vapor.

14.2 Desinfección

Si necesario, desinfectar el producto con un detergente desinfectante común.

Nota Evitar absolutamente utilizar productos ácidos, alcalinos o solventes como acetona o diluyente

15. CONDICIONES DE ELIMINACIÓN

15.1 Condiciones de eliminación generales

No eliminar el producto junto con los desechos sólidos urbanos. Para la eliminación del producto, entregarlo en una isla ecológica municipal en vistas del posterior reciclado de los materiales.

15.2 Advertencias para la eliminación correcta del producto según la directiva europea 2012/19/UE:

Al final de su vida útil, el producto no se deberá eliminar junto con los desechos urbanos. El producto se deberá entregar a los centros de recogida selectiva designados por los ayuntamientos o a los distribuidores que suministren este servicio. La eliminación selectiva del producto permite evitar posibles consecuencias negativas para el medio ambiente y la salud, así como recuperar los materiales que lo componen para obtener un importante ahorro de energías y recursos. Para destacar la obligación de eliminar por separado los aparatos electromédicos, en el producto se ha colocado el símbolo del contenedor tachado.

16. DECLARACIÓN DE COMPATIBILIDAD ELECTROMAGNÉTICA

16.1 Guía y declaración del fabricante - emisiones electromagnéticas

El sistema Lytus está diseñado para funcionar en el ambiente electromagnético especificado a continuación. El cliente o el usuario del sistema Lytus debe garantizar el uso en dicho ambiente.

| PRUEBA DE EMISIÓN | CONFORMIDAD | AMBIENTE ELECTROMAGNÉTICO - GUÍA |
|---|-------------|---|
| Emisiones RF CISPR 11 | Grupo 1 | El sistema Lytus utiliza energía RF sólo para el funcionamiento interno. Por eso sus emisiones RF son muy bajas y no originan interferencias en los aparatos electrónicos cercanos. |
| Emisiones RF CISPR 11 | Clase B | El sistema Lytus es adecuado para el uso en todos los ambientes, incluso en viviendas y en ambientes directamente conectados a la red de alimentación pública de baja tensión que alimenta los edificios de vivienda. |
| Emisiones armónicas IEC 61000-3-2 | Clase A | |
| Emisiones de fluctuación de tensión/flicker IEC 61000-3-3 | Conforme | |

⚠ Atención:

1. El producto no debe utilizarse adyacente o apilado a otros aparatos. En caso de tener que utilizarlo adyacente o apilado a otros aparatos, comprobar el funcionamiento normal del producto en la configuración de uso.
2. El uso de accesorios, transductores y cables diferentes de aquellos especificados o suministrados por el fabricante podría causar mayores emisiones electromagnéticas o una disminución de la inmunidad electromagnética de este aparato y defectos de funcionamiento.
3. El equipo de comunicación RF portátil (incluidos los periféricos, como los cables de la antena y las antenas externas) se debe utilizar por lo menos a 30 cm (12 pulgadas) de cualquier parte de la bomba, incluidos los cables especificados por el fabricante. En caso contrario, podría producirse una degradación de las prestaciones del equipo.

16.2 Guía y declaración del fabricante - inmunidad electromagnética

El sistema Lytus está diseñado para funcionar en el ambiente electromagnético especificado a continuación. El cliente o el usuario del sistema Lytus debe garantizar el uso en dicho ambiente.

| Normas EMC | Nivel de prueba | | Nivel de conformidad | Electromagnetic Environment-Guidance |
|--|--|---|--|---|
| | Ambiente para servicios sanitarios profesionales | Ambiente para servicios sanitarios domésticos | | |
| Descarga electrostática (ESD) IEC 61000-4-2 | ± 8kV contacto ± 15kV aire | | ± 8kV contacto ± 15kV aire | La pavimentación debe ser de madera, cemento o cerámica. Si la pavimentación está revestida de material sintético, la humedad relativa debe ser de al menos el 30%. |
| Transistores/trenes eléctricos veloces IEC61000-4-4 | ± 2kV para líneas de alimentación de potencia ± 1kV para líneas de entrada/salida | | ± 2kV para líneas de alimentación de potencia ± 1kV para líneas de entrada/salida | La calidad de la tensión de red debería ser la de un típico ambiente comercial u hospitalario |
| Sobretensión IEC61000-4-5 | ± 1 kV línea a línea ± 2 kV línea a tierra | ± 1 kV línea a línea | ± 1 kV línea a línea | La alimentación eléctrica de red debería ser la de un típico ambiente comercial u hospitalario |
| Breves ausencias de tensión, breves interrupciones y variaciones de la tensión en las líneas de entrada de la alimentación IEC61000-4-11 | Caídas de tensión: I) reducción del 100% para 0,5 período, II) reducción del 100% para 1 período, III) reducción del 30% para períodos de 25/30, Interrupciones de tensión: Reducción del 100% para períodos de 250/300 | | 230V | La calidad de la tensión de red debería ser la de un típico ambiente comercial u hospitalario. Si el usuario del sistema Lytus requiere el funcionamiento continuo del sistema aun en caso de corte de suministro eléctrico, se recomienda alimentar el sistema Lytus con un grupo de continuidad (UPS) o con baterías. |
| Campo magnético a la frecuencia de red (50/60Hz) IEC61000-4-8 | 30 A/m | 30 A/m | 30 A/m | Los campos magnéticos a la frecuencia de red deberían tener los niveles característicos de un ambiente comercial u hospitalario |

| Normas EMC | Nivel de prueba | | Nivel de conformidad | Electromagnetic Environment-Guidance |
|---------------------------------------|---|--|----------------------|--|
| | Ambiente para servicios sanitarios profesionales | Ambiente para servicios sanitarios domésticos | | |
| RF conducida IEC 61000-4-6 | 3 Vrms 0,15 MHz - 80 MHz 6 Vrms en las bandas ISM entre 0,15 MHz y 80 MHz 80 % AM a 1 kHz | 3 Vrms 0,15 MHz - 80 MHz 6 Vrms en las bandas ISM en las radiofónicas aficionadas 0,15 MHz y 80 MHz 80 % AM a 1 kHz | 6Vrms | El sistema Lytus debe utilizarse sólo en lugares blindados con un mínimo de eficiencia contra las RF y, por cada cable que entra en el local blindado, con un mínimo de atenuación de los filtros RF. Distancia de separación recomendada $d = \sqrt{P}$ 150 kHz a 80 MHz $d = 0.6\sqrt{P}$ 80MHz a 800 MHz $d = 1.2\sqrt{P}$ 800 MHz a 2.7G MHz Donde "P" es el máximo índice de salida del transmisor en vatios (W) según el fabricante del transmisor y "d" es la distancia de separación recomendada expresada en metros (m). Las resistencias de los campos del transmisor fijo RF, determinadas desde un lugar de detección, (a) deben ser inferiores al nivel de conformidad de cada gama de frecuencia. (b) Puede haber interferencia en proximidad de aparatos marcados con el siguiente símbolo:  |
| RF irradiada campo EM IEC61000-4-3 | 3 V/m 80 MHz to 2.7 GHz 80 % AM a 1 kHz 385-6000 MHz, 9-28V/m, 80% AM(1kHz) modalidad por impulsos y otras modulaciones | 10 V/m 80 MHz to 2.7 GHz 80 % AM a 1 kHz 385-6000 MHz, 9-28V/m, 80% AM(1kHz) modalidad por impulsos y otras modulaciones | 10V/m | |

NOTA 1: UT es la tensión de red c.a. antes de la aplicación del nivel de prueba

NOTA 2: A 80MHz y 800MHz se aplica la máxima gama de frecuencia

NOTA 3: Estas pautas podrían no ser válidas en todas las situaciones. La propagación electromagnética es influida por la absorción y la reflexión por parte de estructuras, objetos y personas

a) Las intensidades de campo emitidas por transmisores fijos como las estaciones base para radioteléfonos (móviles e inalámbricos) y radiomóviles terrestres, radioaficionados, radiotransmisores en AM y FM y transmisores TV no se pueden prever de manera teórica con precisión. Para evaluar el ambiente electromagnético originado por transmisores RF fijos es necesario realizar un estudio electromagnético in situ. Si la intensidad de campo medida fuera del local blindado, en el lugar donde se utiliza el sistema Lytus, supera el nivel de conformidad aplicable mencionado, el funcionamiento regular del sistema Lytus se deberá mantener bajo observación. Si se observan anomalías de prestación, podría ser necesario adoptar medidas adicionales, como un cambio de posición del sistema Lytus o el uso de un local blindado con una mayor eficiencia contra las RF y una mayor atenuación de los filtros.

b) Más allá de la gama de frecuencia de 150KHz a 80MHz, el campo de resistencia debería ser inferior a 10 V/m.

16.3 Distancias de separación recomendadas entre los equipos de comunicación portátiles y móviles y el sistema Lytus

El sistema Lytus está diseñado para funcionar en un ambiente electromagnético donde las interferencias RF estén bajo control. El cliente o el usuario del sistema Lytus puede contribuir a evitar interferencias electromagnéticas manteniendo una distancia mínima entre los aparatos de comunicación por radiofrecuencia portátiles y móviles (transmisores) respecto del sistema Lytus según se indica a continuación, en base a la potencia de salida máxima de los aparatos de radiocomunicación.

| Potencia de salida máxima del transmisor especificada W | Distancia de separación a la frecuencia del transmisor (m) | | |
|---|--|------------------------------------|--------------------------------------|
| | De 150 KHz a 80MHz d= \sqrt{P} | De 80MHz a 800MHz d=0.6 \sqrt{P} | De 800MHz a 2.7 GHz d=1.2 \sqrt{P} |
| 0.01 | 0.1 | 0.06 | 0.12 |
| 0.1 | 0.31 | 0.19 | 0.38 |
| 1 | 1 | 0.6 | 1.2 |
| 10 | 3.1 | 1.9 | 3.8 |
| 100 | 10 | 6 | 12 |

Para los transmisores cuya potencia de salida máxima no aparezca indicada, la distancia de separación recomendada en metros (m) puede determinarse utilizando la ecuación aplicable a la frecuencia del transmisor, donde P es la potencia de salida nominal máxima del transmisor en vatios (W) según lo indicado por el fabricante del transmisor.

NOTA 1 A 80MHz y 800MHz se aplica el intervalo de frecuencia más alto.

NOTA 2: estas pautas podrían no ser válidas en todas las situaciones. La propagación electromagnética es influida por la absorción y la reflexión por parte de estructuras, objetos y personas

17. REPUESTOS Y ACCESORIOS

Para conseguir repuestos y accesorios, consultar exclusivamente el catálogo general Moretti.

MR319 Mando de pedal eléctrico para la regulación de la elevación de la cama en MI37XX

MR320 Mando de pedal eléctrico para la regulación del levanta-cabeza en MI380X-MI381X-MI390X-MI391X

MR321 Mando de pedal eléctrico para la regulación de la elevación de la cama en MI380X-MI381X-MI390X-MI391X

MIA391 Soporte portarrollo de 60cm para MI37XX

MIA392 Soporte portarrollo de 60cm para MI380X-MI381X-MI385X-MI386X

MIA393 Soporte portarrollo de 60cm para MI390X-MI391X-MI395X-MI396X





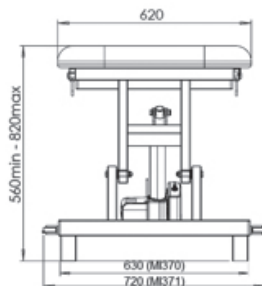
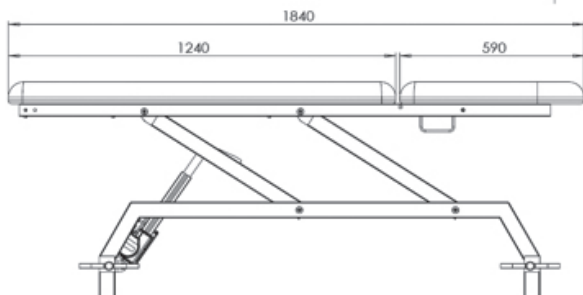

MIA394 Soporte portarrollo de 80cm para MI390X-MI391X-MI395X-MI396X

18. CARACTERÍSTICAS TÉCNICAS

18.1 Medidas y peso MI370X - MI371X







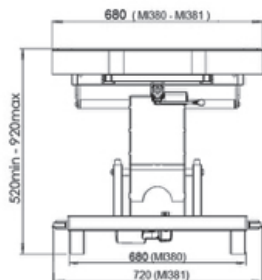
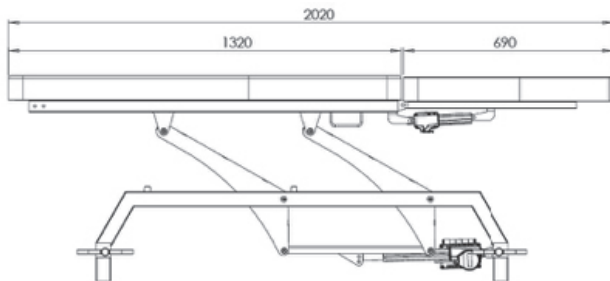

| | |
|-------------------------------|-------------|
| Medidas externas (MI370): | mm 1840x630 |
| Medidas externas (MI371): | mm 1840x720 |
| Altura mín. | mm 560 |
| Altura máx. | mm 820 |
| Ángulo máximo levanta-cabeza: | 60° |

| | | | |
|--|--|---|---|
|  Medidas embalaje MI370-MI371 |  L: 1850 mm |  P: 730 mm |  H: 570 mm |
|  Peso embalaje MI370-MI371 | 54 kg | | |
|  Peso cama MI370-MI371 | 48 kg | | |
|  Capacidad máxima | 150 kg | | |

18.2 Medidas y peso MI380X - MI381X







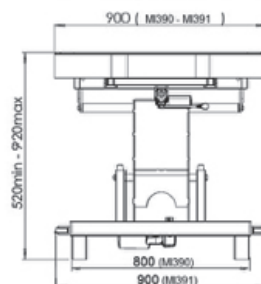
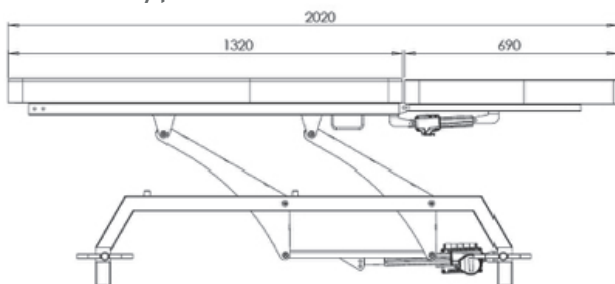

| | |
|-------------------------------|-------------|
| Medidas externas (MI380X): | mm 2020x680 |
| Medidas externas (MI381X): | mm 2020x720 |
| Altura mín. | mm 520 |
| Altura máx. | mm 920 |
| Ángulo máximo levanta-cabeza: | 60° |

| | | | |
|--|--|---|---|
|  Medidas embalaje MI380-MI381 |  L: 1785 mm |  P: 730 mm |  H: 535 mm |
|  Peso embalaje MI380-MI381 | 68 kg | | |
|  Peso cama MI380-MI381 | 60 kg | | |
|  Capacidad máxima | 200 kg | | |

18.3 Medidas y peso MI390X - MI391X







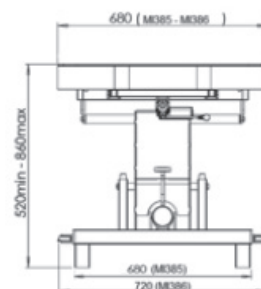
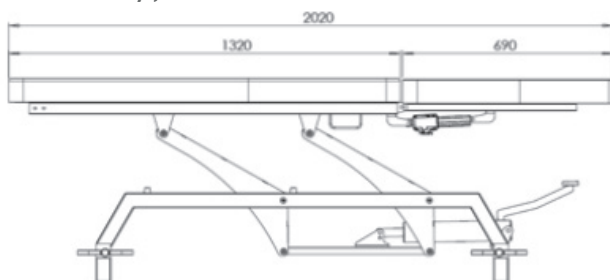

| | |
|-------------------------------|-------------|
| Medidas externas (MI390X): | mm 2020x800 |
| Medidas externas (MI391X): | mm 2020x900 |
| Altura mín. | mm 520 |
| Altura máx. | mm 920 |
| Ángulo máximo levanta-cabeza: | 60° |

| | | | |
|--|--|---|---|
|  Medidas embalaje MI390-MI391 |  L: 2040 mm |  P: 940 mm |  H: 535 mm |
|  Peso embalaje MI390-MI391 | 86 kg | | |
|  Peso cama MI390-MI391 | 75 kg | | |
|  Capacidad máxima | 200 kg | | |

18.4 Medidas y peso MI385X - MI386X







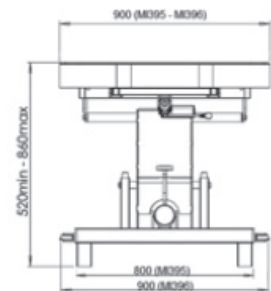
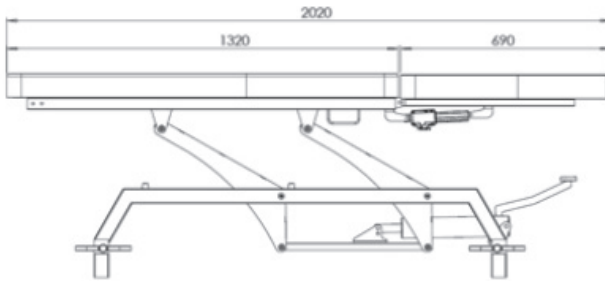

| | |
|-------------------------------|-------------|
| Medidas externas (MI385X): | mm 2020x680 |
| Medidas externas (MI386X): | mm 2020x720 |
| Altura mín. | mm 520 |
| Altura máx. | mm 860 |
| Ángulo máximo levanta-cabeza: | 60° |

| | | | |
|--|--|---|---|
|  Medidas embalaje MI385-MI386 |  L: 2040 mm |  P: 730 mm |  H: 535 mm |
|  Peso embalaje MI385-MI386 | 69 kg | | |
|  Peso cama MI385-MI386 | 61 kg | | |
|  Capacidad máxima | 180 kg | | |

18.5 Medidas y peso MI395X - MI396X



| | |
|-------------------------------|-------------|
| Medidas externas (MI395X): | mm 2020x900 |
| Medidas externas (MI396X): | mm 2020x900 |
| Altura mín. | mm 520 |
| Altura máx. | mm 860 |
| Ángulo máximo levanta-cabeza: | 60° |

| | | | |
|--|--|---|---|
|  Medidas embalaje MI395-MI396 |  L: 2040 mm |  P: 940 mm |  H: 535 mm |
|  Peso embalaje MI395-MI396 | 89 kg | | |
|  Peso cama MI395-MI396 | 78 kg | | |
|  Capacidad máxima | 180 kg | | |

18.6 Especificaciones técnicas

| | |
|--|--|
| Fuerza necesaria para accionar los mandos en el mando a distancia (MI37XX-MI380-MI381-MI390-MI391) | 5 N |
| Fuerza necesaria para accionar el pedal (MI385-MI386-MI395-MI396) | 30N |
| Alimentación eléctrica | 220-240V CA 50Hz, 600 mA |
| Tensión de salida de la centralita | 24 Vcc |
| Clase de protección | IP 54 |
| Nivel de ruido | < 45 DB |
| Clase de aislamiento | Clase 2 |
| Materiales utilizados | Estructura tubular de acero pintado con polvos, superficie de goma espuma revestida de PVC |

19. RESOLUCIÓN DE PROBLEMAS

| PROBLEMA | POSIBLE CAUSA | SOLUCIÓN |
|---|---|--|
| No funciona ningún mando | <ol style="list-style-type: none"> 1. La clavija eléctrica no está conectada a la toma de tensión de red 2. El mando a distancia no está conectado a la centralita 3. Probable defecto en el mando a distancia o la centralita | <ol style="list-style-type: none"> 1. Conectar la clavija eléctrica 2. Controlar y eventualmente conectar el mando a distancia a la centralita 3. Contactar con el centro de asistencia para un diagnóstico más preciso del problema |
| El levanta-cabeza eléctrico no funciona | <ol style="list-style-type: none"> 1. El actuador del levanta-cabeza no está conectado a la centralita 2. El actuador o el mando a distancia o la centralita puede tener algún defecto | <ol style="list-style-type: none"> 1. Controlar y eventualmente conectar el actuador a la centralita 2. Contactar con el centro de asistencia para un diagnóstico más preciso del problema |
| La elevación eléctrica de la cama no funciona | <ol style="list-style-type: none"> 1. El actuador de elevación no está conectado a la centralita 2. El actuador o el mando a distancia o la centralita puede tener algún defecto | <ol style="list-style-type: none"> 1. Controlar y eventualmente conectar el actuador a la centralita 2. Contactar con el centro de asistencia para un diagnóstico más preciso del problema |
| El mando de pedal no funciona | <ol style="list-style-type: none"> 1. El mando de pedal no está conectado al cable Y 2. El cable Y no está conectado a la centralita 3. La centralita electrónica y los actuadores podrían ser defectuosos | <ol style="list-style-type: none"> 1. Controlar y eventualmente conectar el mando de pedal al cable Y 2. Conectar el cable en Y a la centralita 3. Contactar con el centro de asistencia para un diagnóstico más preciso del problema |

20. GARANTÍA

Todos los productos Moretti tienen una garantía de 2 años desde la fecha de venta por defectos de fabricación o de material, sin perjuicio de eventuales exclusiones y de las limitaciones especificadas a continuación.

La garantía no se aplica en caso de daños causados por uso inadecuado, abusos, alteraciones y en caso de que no se respeten las instrucciones de uso. La finalidad correcta del producto está indicada en el manual de instrucciones.

Moretti no es responsable por los daños provocados por una instalación o uso del dispositivo no conforme con las instrucciones que se encuentran en el manual de instalación, montaje y uso.

Moretti no garantiza los productos Moretti por daños o defectos en la condiciones siguientes: calamidades, operaciones de mantenimiento o reparación no autorizadas, daños causados por la alimentación eléctrica (si está prevista), uso de piezas no suministradas por Moretti, incumplimiento de las instrucciones de uso, modificaciones no autorizadas, daños durante el envío (diferente del envío original de Moretti), falta del mantenimiento indicado por el manual.

No están cubiertas por la garantía piezas sujetas a deterioro si el daño es causado por el uso normal del producto.

21. REPARACIONES

21.1 Reparación en garantía

Si un producto Moretti presenta defectos de material o de fabricación durante el período de garantía, Moretti evaluará con el cliente si el defecto del producto está cubierto por la garantía. Moretti a su discreción puede sustituir o reparar el artículo en garantía en la dirección de un revendedor Moretti especificado o en su propia sede. Los costes de mano de obra para la reparación del producto pueden estar a cargo de Moretti si se determina que la reparación está cubierta por la garantía. Una reparación o sustitución no renueva ni prorroga la garantía.

21.2 Reparación de un producto no cubierto por la garantía

Un producto no cubierto por la garantía podrá ser devuelto para la reparación sólo con la autorización previa del servicio Clientes de Moretti. Los costes de mano de obra y envío relativos a una reparación no cubierta por la garantía estarán totalmente a cargo del cliente o del revendedor. Las reparaciones de productos no cubiertos por la garantía tienen una garantía de 6 (seis) meses desde la fecha de entrega del producto reparado.

21.3 Productos no defectuosos

Tras la evaluación y la prueba de un producto devuelto, Moretti notificará al cliente en el caso de que el producto no resulte defectuoso. El producto será devuelto al cliente y estarán a su cargo los costes de devolución.

22. REPUESTOS

Los repuestos originales Moretti tienen una garantía de 6 (seis) meses desde la fecha de entrega del repuesto

23. CLÁUSULAS EXONERATIVAS

Más allá de las especificaciones de esta garantía y dentro de los límites de ley, Moretti no ofrece ninguna otra declaración, garantía o condición expresa o implícita con respecto a la aptitud para la comercialización, la idoneidad para fines particulares, la no-violación y la no-interferencia. Moretti no garantiza que el uso del producto Moretti no pueda presentar interrupciones o errores. La duración de eventuales garantías implícitas que puedan ser impuestas por normas de ley se limita al período de garantía conforme a los límites de ley. Algunos estados o países no permiten limitaciones de la duración de la garantía implícita o la exclusión o limitación de daños accidentales o indirectos en relación con productos para los consumidores. En dichos estados y países, algunas exclusiones o limitaciones de esta garantía podrían no aplicarse al usuario. La presente garantía está sujeta a variaciones sin aviso previo.



NOTA



CERTIFICADO DE GARANTÍA

Producto _____

Fecha de compra _____

Distribuidor _____

Calle _____ **Localidad** _____

Vendido a _____

Calle _____ **Localidad** _____

ESPAÑOL



Via Bruxelles, 3 - Melegnano 20139 Cavriaglia (Arezzo) Tel. +39 055 96 21 11

www.morettispa.com email: info@morettispa.com

MADE IN ITALY

MORETTI S.P.A.

Via Bruxelles, 3 - Meleto
52022 Cavriglia (Arezzo)

Tel. +39 055 96 21 11
Fax. +39 055 96 21 200

www.morettispa.com
info@morettispa.com